



PIR40



OPTIONAL REMOTE
Not Included (Order MSR1)



PERFORMANCE

| | |
|------------------------------|---|
| Operating voltage | 10.5 - 15V |
| Operating current | 30mA |
| Output | DIM 0-10V |
| Brightness | 70%/80%/90%/100% |
| Detection area / Sensitivity | 25%/50%/75%/100% |
| Hold time | 5s, 30s, 1min, 3min, 5min, 10min, 20min, or 30min |
| Daylight threshold | Disable, 2lux, 10lux, 30lux, 50lux, 80lux, 120lux, 200lux, 250lux, 300lux, 350lux, 400lux |
| Stand-by period | 0s, 10s, 30s, 1min, 5min, 10min, 30min, 60min, +∞ |
| Stand-by dimming level | 10%/20%/30%/50% |
| Detection angle | <120° with Fresnel Lens |
| Mounting height | Max 40ft (<i>ceiling mounted</i>) |
| Detection range | Max Diameter 40ft (<i>ceiling mounted</i>) |
| Operating temperature | -20°C ~ +70°C (-4°F ~ 158°F) |
| IP rating | IP65 |

PIR40 - PASSIVE INFRARED OCCUPANCY AND DAYLIGHT SENSOR **RAB**

PIR SENSOR FACTORY SETTINGS

| | |
|------------------------|------------|
| BRIGHTNESS | 100% |
| HOLD TIME | 20 Minutes |
| DAYLIGHT | Disabled |
| SENSITIVITY | 100% |
| STAND-BY DIMMING LEVEL | 20% |
| STAND-BY TIME | 1 Minute |

DIMENSIONS (UNIT: INCH)

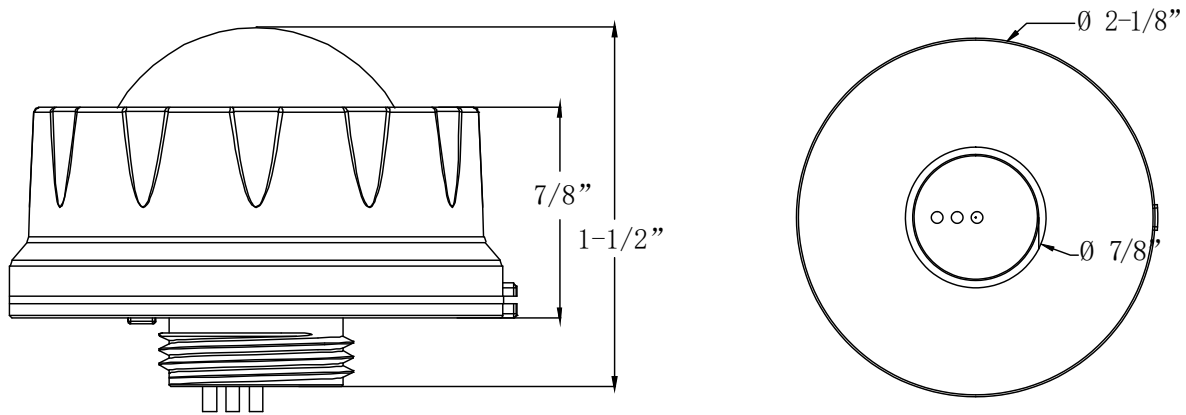

DETECTION COVERAGE (UNIT: FEET)

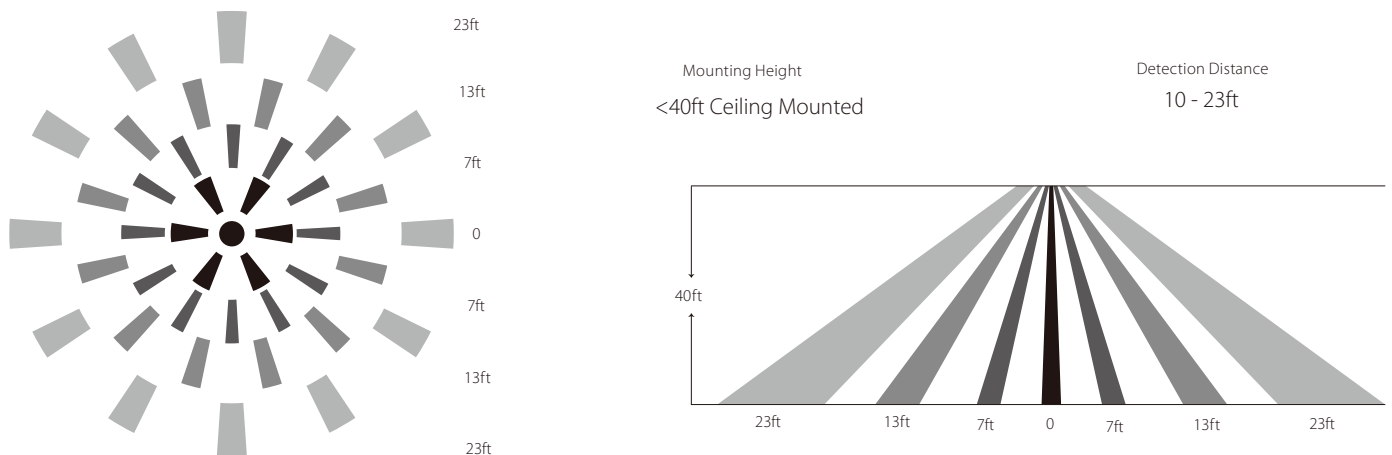

LUX ON-OFF

Sensor automatically turns on light when ambient brightness is lower than preset lux level. Following preconditions apply to use the Lux On-Off function:

Use below settings for the Lux on-off function:

- Stand-by period: Set to infinity (∞)
- Stand-by dimming level: 10%, 20% or 30% (*only*)
- Daylight threshold: 30lux, 50lux, 80lux or 120lux, 200lux, 250lux, 300lux, 350lux, 400lux

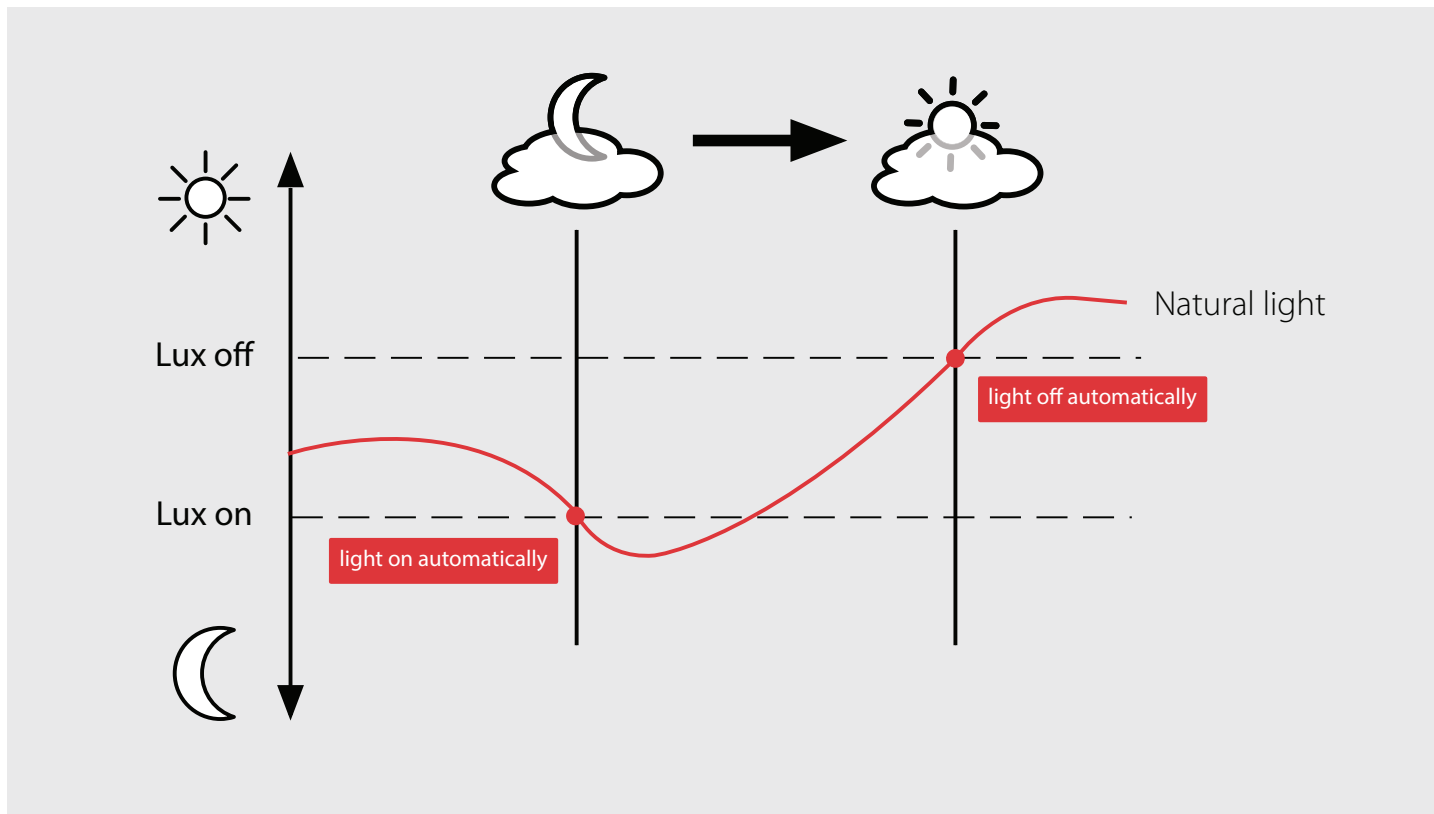

1. With daylight Lux setting selected

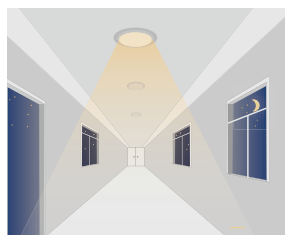

With insufficient ambient brightness, sensor turns on light and keeps it at standby dimming level even if there is no motion or presence.

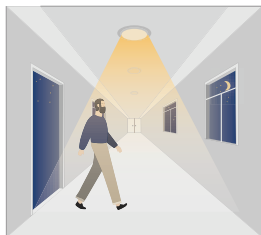

When sensor detects motion or presence it will bring the light level up to 100%.

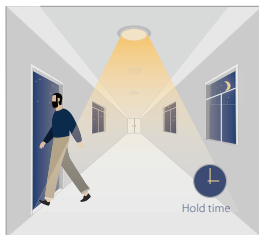

After motion is no longer detected, fixture remains at 100% for hold time.

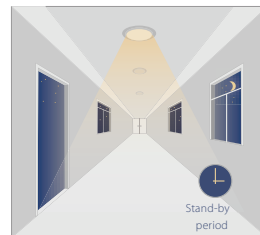

After pre-set hold time period it will dim light to standby dimming level and always keep it.

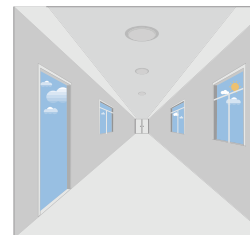

With sufficient ambient brightness, sensor will turn OFF light automatically.

2. PIR Sensor

With daylight threshold disabled



Sensor turns ON light when motion is detected.

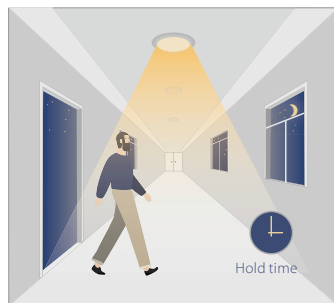

Sensor keeps for a hold time period after motion leaves.

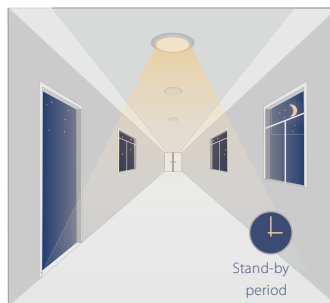

Sensor dims light to standby dimming level after hold time if there is still no motion.



Sensor turns OFF light after standby period.

3. With daylight threshold

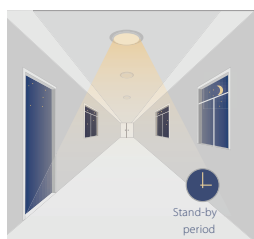

With sufficient daylight, the sensor keeps light OFF even when motion gets detected.

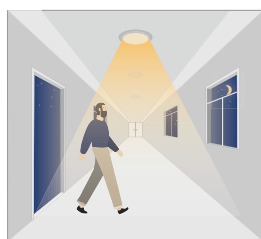

With insufficient daylight, the sensor turns light ON when motion is detected.

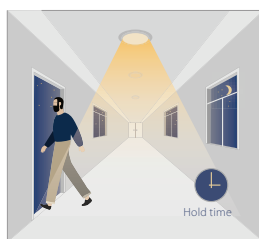

After there is no motion detected, the sensor keeps light ON 100% for holdtime.

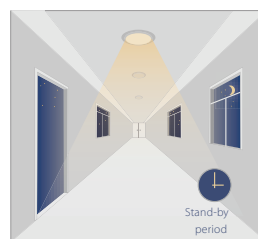

After holdtime, sensor dims light to standby dimming level for standby period. If the standby period has been set as 0S, sensor turns light OFF automatically after holdtime.

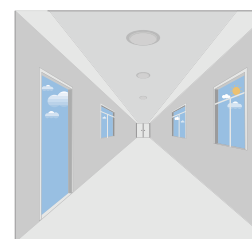

The sensor turns OFF light automatically after the standby period when there is no motion detected.

Note: These instructions do not cover all details or variations in equipment nor do they provide for every possible situation during installation, operation or maintenance.