

## PS-1250 12 Volt 5.0 AH

### Rechargeable Sealed Lead Acid Battery



We've Got The Power.™



### Terminals: (mm)

- F1 - Quick disconnect tabs, 0.187" x 0.032" - Mate with AMP. INC. FASTON "187" series
- OR —
- F2 - Quick disconnect tabs, 0.250" x 0.032" - Mate with AMP. INC FASTON "250" series

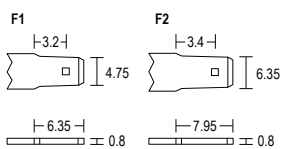

### Physical Dimensions: in (mm)

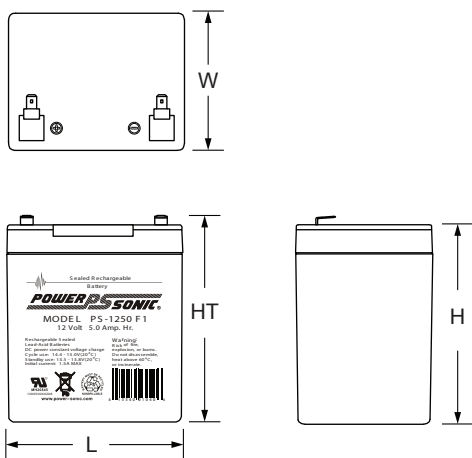

**L:** 3.54 (90) **W:** 2.76 (70) **H:** 3.98 (101) **HT:** 4.21 (107)

Tolerances are +/- 0.04 in. (+/- 1mm) and +/- 0.08 in. (+/- 2mm) for height dimensions. All data subject to change without notice.

### Features

- Absorbent Glass Mat (AGM) technology for superior performance
- Valve regulated, spill proof construction allows safe operation in any position
- Power/volume ratio yielding unrivaled energy density
- Rugged impact resistant ABS case and cover (UL94-HB)
- Approved for transport by air. D.O.T., I.A.T.A., F.A.A. and C.A.B. certified
- U.L. recognized under file number MH 20845

### Performance Specifications

**Nominal Voltage** ..... 12 volts (6 cells)

#### Nominal Capacity

20-hr. (250mA to 10.50 volts) .....	5.00 AH
10-hr. (450mA to 10.50 volts) .....	4.50 AH
5-hr. (750mA to 10.20 volts) .....	3.75 AH
1-hr. (2.85A to 9.00 volts) .....	2.85 AH
15-min. (9A to 9.00 volts) .....	2.25 AH

**Approximate Weight** ..... 3.50 lbs. (1.59 kg)

**Energy Density (20-hr. rate)** ..... 1.54 W-h/in<sup>3</sup> (94.16 W-h/l)

**Specific Energy (20-hr. rate)** ..... 17.14 W-h/lb (37.79 W-h/kg)

**Internal Resistance (approx.)** ..... 40 milliohms

**Max Discharge Current (7 Min.)** ..... 15.0 amperes

**Max Short-Duration Discharge Current (10 Sec.)** ..... 50.0 amperes

#### Shelf Life (% of nominal capacity at 68°F (20°C))

1 Month .....	97%
3 Months .....	91%
6 Months .....	83%

#### Operating Temperature Range

Charge .....	-4°F (-20°C) to 122°F (50°C)
Discharge .....	-40°F (-40°C) to 140°F (60°C)

**Case** ..... ABS Plastic

**Power-Sonic Chargers** ..... PSC-12500A-C

**Shelf Life & Storage**

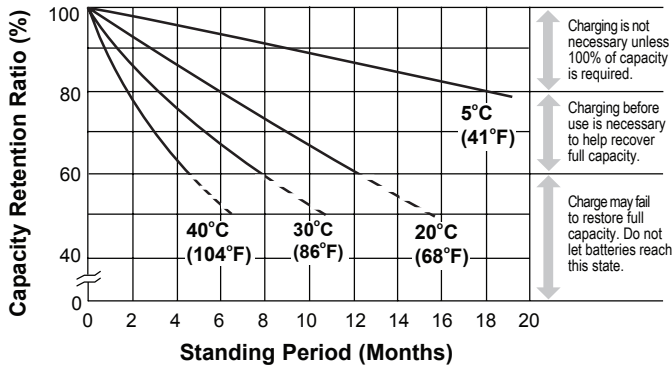

**Discharge Characteristics**

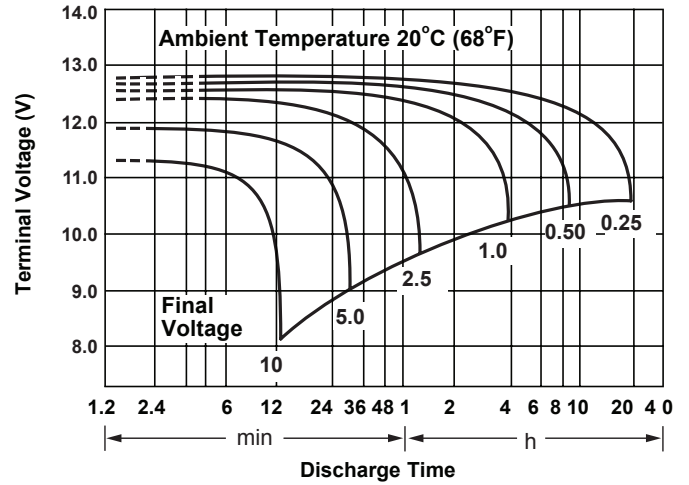

**Discharge Time vs. Discharge Current**

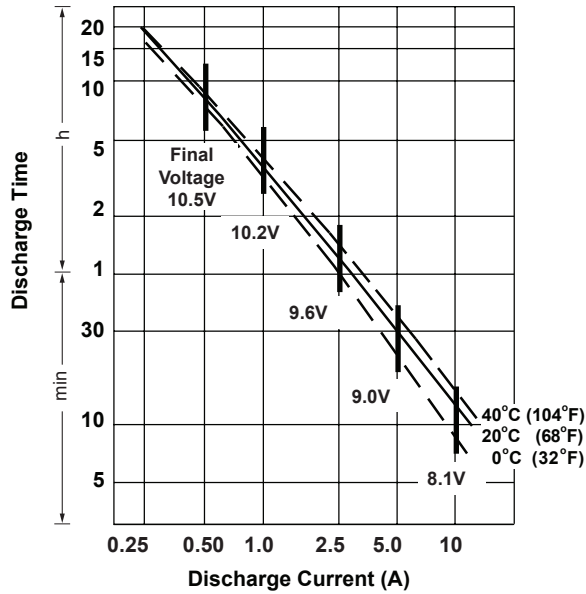

**Life Characteristics in Stand-By Use**

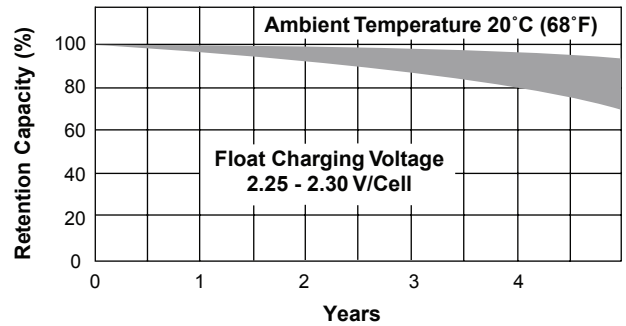

**Life Characteristics in Cyclic Use**

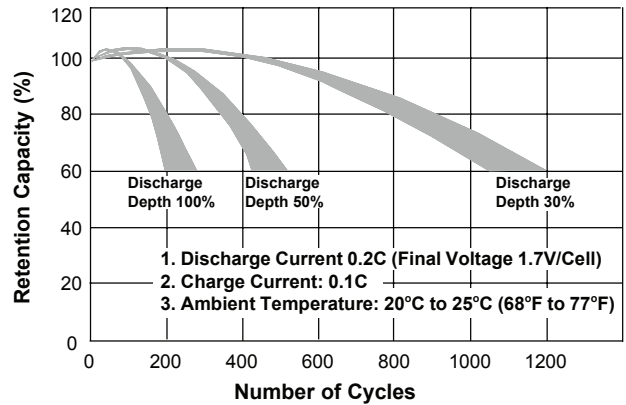

**Charging**

**Cycle Applications:** Limit initial current to 1.2A. Charge until battery voltage (under charge) reaches 14.4 to 14.7 volts at 68°F (20°C). Hold at 14.4 to 14.7 volts until current drops to under 50mA. Battery is fully charged under these conditions, and charger should be disconnected or switched to "float" voltage.

**"Float" or "Stand-By" Service:** Hold battery across constant voltage source of 13.5 to 13.8 volts continuously. When held at this voltage, the battery will seek its own current level and maintain itself in a fully charged condition.

**Note:** Due to the self-discharge characteristics of this type of battery, it is imperative that they be charged within 6 months of storage, otherwise permanent loss of capacity might occur as a result of sulfation.

**Chargers**

Power-Sonic offers a wide range of chargers suitable for batteries up to 100AH. Please refer to the Charger Selection Guide in our specification sheets for "C-Series Switch Mode Chargers" and "Transformer Type A and F Series". Please contact our Technical department for advice if you have difficulty in locating suitable models.

**Further Information**

Please refer to our website [www.power-sonic.com](http://www.power-sonic.com) for a complete range of useful downloads, such as product catalogs, material safety data sheets (MSDS), ISO certification, etc.

**Contact Information**

<p><b>DOMESTIC SALES</b> Tel: +1-619-661-2020 Fax: +1-619-661-3650 national-sales@power-sonic.com</p>	<p><b>CUSTOMER SERVICE</b> Tel: +1-619-661-2030 Fax: +1-619-661-3648 customer-service@power-sonic.com</p>	<p><b>TECHNICAL SUPPORT</b> Tel: +1-619-661-2020 Fax: +1-619-661-3648 support@power-sonic.com</p>	<p><b>INTERNATIONAL SALES</b> Tel: +1-650-364-5001 Fax: +1-650-366-3662 international-sales@power-sonic.com</p>
---	---	---	---