

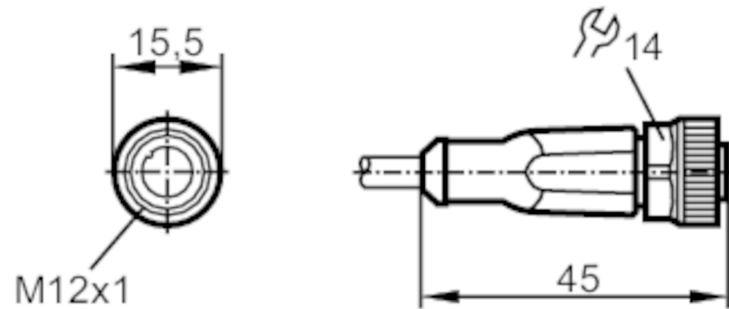

Connecting cable with socket

ADOGH050MSS0025H05



Application

Special feature	Free from silicone; Halogen-free; Gold-plated contacts; Drag chain suitability
Free from silicone	yes

Electrical data

Operating voltage [V]	< 60 AC/DC
Protection class	II
Max. current load total [A]	4; (cULus: 3)

Operating conditions

Ambient temperature [°C]	-25...90
Note on ambient temperature	cULus: ...75
Ambient temperature (moving) [°C]	-25...90
Note on ambient temperature (moving)	cULus: ...75
Protection	IP 65; IP 67; IP 68; IP 69K

EVC199



Connecting cable with socket

ADOGH050MSS0025H05

Mechanical data		
Weight [g]	857.8	
Dimensions [mm]	15.5 x 15.5 x 45	
Materials	housing: TPU orange; Sealing: FKM	
Material nut	brass, nickel-plated	
Drag chain suitability	yes	
Drag chain suitability	bending radius for flexible use	min. 10 x cable diameter
	travel speed	max. 3.3 m/s for a horizontal travel length of 5 m and max. acceleration of 5 m/s ²
	bending cycles	> 5 Mio.
	torsional strain	± 180 °/m

Remarks	
Notes	Please see the technical note under "Downloads"
Pack quantity	1 pcs.

Electrical connection
Cable: 25 m, PUR, Halogen-free, black, Ø 4.6 mm; 5 x 0.34 mm² (42 x Ø 0.1 mm)

Electrical connection - socket
Connector: 1 x M12, straight; Locking: brass, nickel-plated; Contacts: gold-plated; Tightening torque: 0.6...1.5 Nm

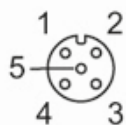



Connecting cable with socket

ADOGH050MSS0025H05

Connection

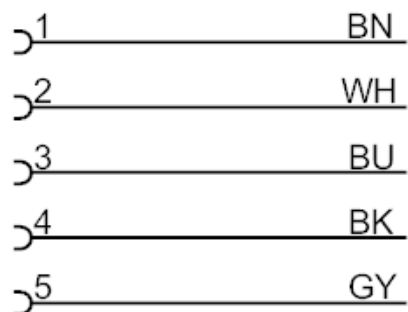

Core colours :

BK =	black
BN =	brown
BU =	blue
GY =	grey
WH =	white

Diagrams and graphs



Derating $I_{max} * 0.8$ DIN EN 60512-5-2

- X Ambient temperature [°C]
- Y Current [A]