

ø22mm XW E-Stops ..... 277

# XW Series E-Stops



[www.IDEC.com/usa/estop](http://www.IDEC.com/usa/estop)



## Revolutionary "Safe Break Action" Design

The IDEC Emergency Stop switches, the X6, XA, XW, and XN series, include revolutionary new technology that have changed the way E-Stop switches are designed. This "safe break action" concept provides greater levels of human safety and is the first of its kind in the world!

### Innovative Design

Conventional E-Stop switches are designed with spring pressure on the Normally Closed (NC) contacts, keeping them in the closed position and allowing the machine to operate. Improper installation or excessive force to the stop button in an emergency may break or dislodge a vital part, causing the spring loaded contact to stay closed. This situation renders the E-Stop incapable of stopping the machine, and can lead to catastrophic events, personal injury and possible loss of life.

### Safe Break Action Design



This one-of-a-kind "safe break action" design, found only in the IDEC XA, XW, and XN series, reverses the energy direction and uses the spring-pressure to assure that the NC contacts will open if the emergency switch is damaged or the contact blocks separate due to excessive force. The NC contacts will reliably open, even if they are welded, and stop the machine. Combined with IDEC quality, this is the E-Stop switch you want in a life threatening situation.

### Level 4 Safety

#### X6, XA, XW & XN Series, The Safe Break Action E-Stops!

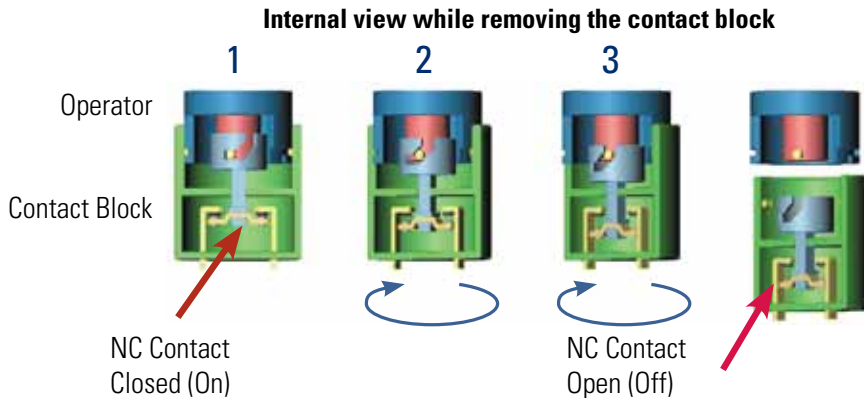

The X Series of E-Stop switches include up to four contacts in a very compact package. In today's automated world, more customers are requiring E-Stop switches with at least three contacts. (Two of the contacts trip the power and the third contact is used to alert a safety-monitoring relay.) Both the XA and XW series switches offer up to four "safe-break" contacts with a depth behind the panel that is half the size of conventional E-Stop switches. This means that there is an additional contact available and the **switches can be used in Level 4 safety category applications.**

IDEC's new E-Stop switches are secured from the rear of the control panel so that the E-Stop cannot be removed from the front. Another unique feature of the XA & XW E-Stop switches is that either a push-turn or push-pull reset method can be used to reset the switches. This eliminates any possible confusion for operators when resetting the switch. The durability and quality of these new E-Stop switches make them extremely reliable. They can withstand the increased high stress caused by panic or a reaction to an emergency situation.

### Reach for the "Safe Break Action"

When the contact block is removed from the operator the main contact (NC) is forced to open (OFF). When removing the contact block, the cam provides a direct opening action to open the contact.

### Padlock E-Stops

As shown in the diagram, upon latching a traditional E-stop, it is up to the technician to verify and confirm that the machine area is clear and there are no other technicians working before resetting the E-stop and turning on the machine. There is always a chance that the technician might miss someone in the work area before resetting the E-stop, potentially causing injury to that person.

The solution is XN4E series padlock E-Stops, which allow technicians to install their personal padlocks at the spot of actuation of the E-Stop ensuring their own safety. The diagram shows how personal padlocks can be installed. Each one blocks the resetting of the E-stop until all the padlocks are removed. This provides added safety and prevents unauthorized or accidental resetting of the E-stops. A maximum of 20 padlocks can be installed by using lockout hasps.

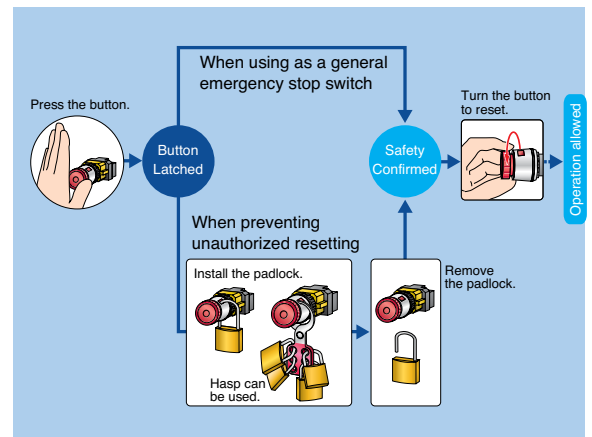

Important Safety Information

Reverse Energy Structure

With X Series E-Stops, the potential energy level of the latched status is lower than that of the normal status. When the switch is damaged due to excessive shocks, the NC contacts will turn off, thus stopping the machine (patented design).

Direct Opening Action

Even if the contacts are welded, the force applied on the button directly opens the contact.

Rated Insulation Voltage: 250V  
 Rated Thermal Current: 2.5A

Safety Interlock Mechanism

Contacts are opened when the operator is locked, and remain opened until the operator is unlocked intentionally. (IEC60947-5; 6:2)

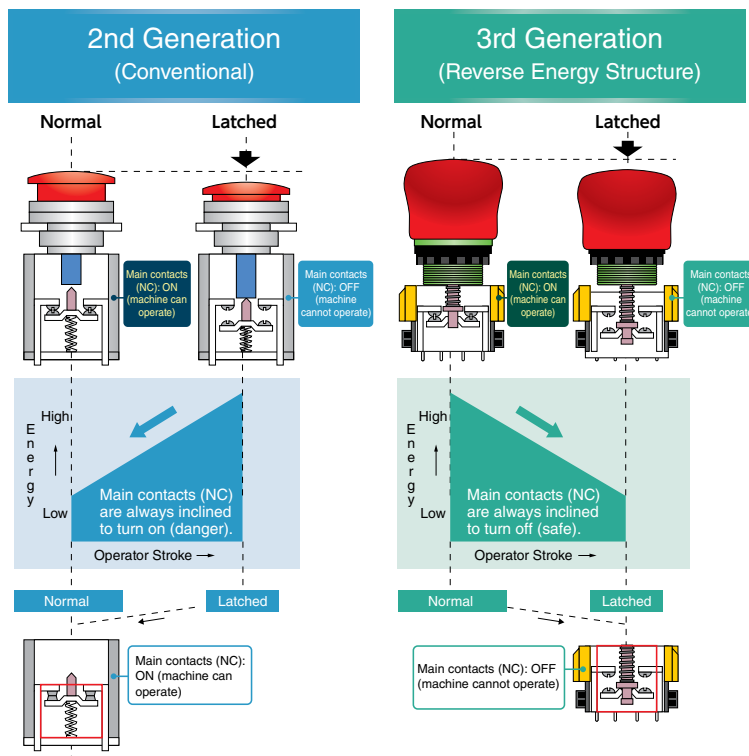

Two E-Stops in One

Pushlock Pull or Turn Reset

The X Series E-Stops can be reset either by pulling or turning the button. This ensures that the reset action will always be different from the make action. With traditional E-Stops, you need to choose between Push-Pull or Pushlock Turn Reset. With the IDEC X Series E-Stops you get both in one switch.

XN4E, padlock type is Turn Reset only.

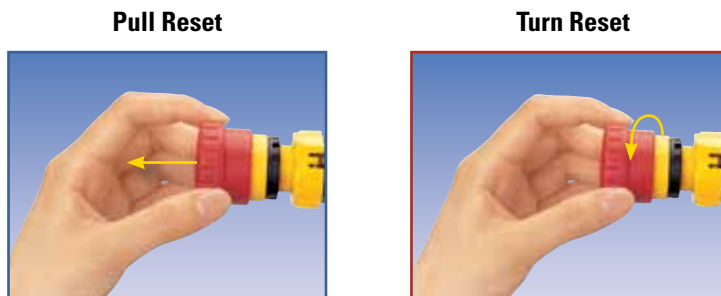

Compact

Compact Body with Four Contacts

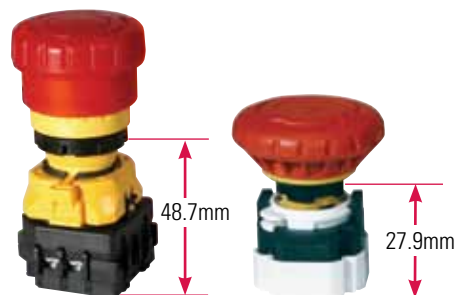

Traditional E-Stop

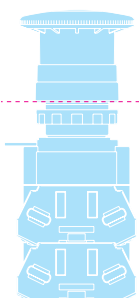

22mm XW and 16mm XA Series

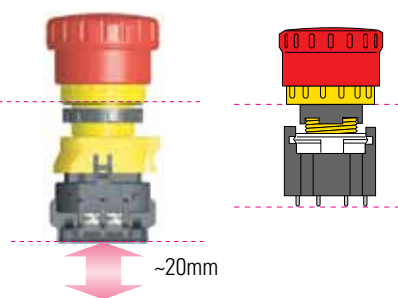

XN Series

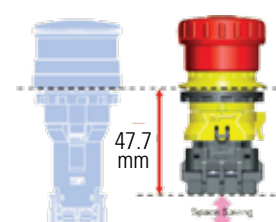

Selection Guide

Overview

XW Series E-Stops





Interlock Switches

Enabling Switches

Safety Control

Light Curtains

AS-Interface Safety at Work

| Series                | X6   | XA  | XW   | XN  |
|-----------------------|--|---|--|---|
| Appearance            |     |  |  |  |
| Page                  | see Switches & Pilot Devices section   | see Switches & Pilot Devices section  | 277  | see Switches & Pilot Devices section  |
| Mounting Hole         | 16mm   | 16mm  | 22mm   | 30mm  |
| Operator Type         | Non-Illuminated E-Stops: Pushlock Pull/Turn Reset                                    | Illuminated & Non-Illuminated E-Stops: Pushlock/Turn Reset, Push-Pull             |  |   |
| Reset Action          | Pushlock Pull or Turn Reset (both actions available in each switch, except XN4E)     |   |  |   |
| Contact Configuration | 1NC, 2NC   | 1NO - 1NC, 2NC, 1NO-3NC, 4NC  |  |   |
| Electrical Life       | 100,000 Minimum  |   |  |   |
| Mechanical Life       | 100,000 Minimum  | 250,000 Minimum   |  |   |
| Termination           | Solder/Tab Terminals   | PCB & Solder Terminals  | Screw Terminals  |   |
| Degree of Protection  | IP65 (IEC 60529)   | IP65 (IEC60529)   | Operator: IP65 (IEC60529)<br>Terminal: IP20 (when XW9Z-VL2MF is installed)         |   |
| Approvals             |  |   |  |   |

 X6 and XA series UL recognized.

## 22mm XW E-Stops

### Key features:

- The depth behind the panel can be as little as 46.4 mm for 1 to 4 contacts (with terminal cover) for illuminated and non-illuminated units.
- IDEC's original "Safe break action" ensures that the NC contacts open when the contact block is detached from the operator.
- 1 to 4NC main contacts and 1 or 2NO monitor contacts
- Push-to-lock, Pull or Turn-to-reset operator
- Models with mechanical indicator on the operator body show the normal/latched status (green: normal).
- Safety lock mechanism (IEC60947-5-5, 6.2)
- Degree of protection IP65 (IEC60529)
- Fingersafe (IP20) terminals
- Three button sizes: ø38, ø40 and ø60 mm
- Push-ON illumination type available (40mm mushroom head)
- Direct opening action mechanism (IEC60947-5-5, 5.2, IEC60947-5-1, Annex K)
- RoHS compliant (EU directive 2002/95/EC).
- UL c-UL listed. EN compliant
- UL NISD category emergency stop device (File# E305148)



UL File #E68961



CCC No. 2005010305150897







### Specifications



|  |   |
|--|---|
| Applicable Standards                                   | IEC60947-5-5, EN60947-5-5, JIS C8201-5-1, UL508, UL991, NFPA79, CSA C22.2 No. 14, GB14048.5   |
| Operating Temperature                                  | Non-illuminated: -25 to +60°C (no freezing), Illuminated: -25 to +55°C (no freezing)  |
| Operating Humidity                                     | 45 to 85% RH (no condensation)  |
| Storage Temperature                                    | -45 to +80°C  |
| Operating Force  | Push-to-lock: 32N<br>Pull-to-reset: 21N<br>Turn-to-reset: 0.27N·m   |
| Minimum Force Required for Direct Opening Action       | 80N   |
| Min Operator Stroke Required for Direct Opening Action | 4mm   |
| Maximum Operator Stroke                                | 4.5mm   |
| Contact Resistance                                     | 50mΩ maximum (initial value)  |
| Contact Material                                       | Gold plated silver  |
| Insulation Resistance                                  | 100MΩ minimum (500V DC megger)  |
| Impulse Withstand Voltage                              | 2.5kV   |
| Pollution Degree                                       | 3   |
| Operation Frequency                                    | 900 operations/hour   |
| Shock Resistance                                       | Operating extremes: 150m/s <sup>2</sup> (15G), Damage limits: 1000m/s <sup>2</sup> (100G)   |
| Vibration Resistance                                   | Operating extremes: 10 to 500Hz, amplitude 0.35mm acceleration 50m/s <sup>2</sup><br>Damage limits: 10 to 500Hz, amplitude 0.35mm acceleration 50m/s <sup>2</sup> |
| Mechanical Life  | 250,000 operations minimum  |
| Electrical Life  | 100,000 operations minimum, (250,000 operations minimum @ 24V AC/DC, 100mA)   |
| Degree of Protection                                   | Operator: IP65 (IEC60529)<br>Terminal: IP20 (when XW9Z-VL2MF is installed)  |
| Terminal Style   | M3.0 screw terminal   |
| Recommended Tightening Torque for Locking Ring         | 2.0N·m  |
| Wire Size  | 16 AWG max  |
| Weight   | ø40mm: 72g<br>ø60mm: 81g  |

Part Numbers

Standard Button Without Mechanical Indicator

| Style   | Operator Type                             | Monitor Contact | Main Contact | Part Number     |
|---|---|-----------------|--------------|-----------------|
| Non-Illuminated<br>          | 40mm Mushroom                             | 1NO             | 1NC          | XW1E-BV411M-R   |
|   |   | -               | 2NC          | XW1E-BV402M-R   |
|   |   | 2NO             | 2NC          | XW1E-BV422M-R   |
|   |   | 1NO             | 3NC          | XW1E-BV413M-R   |
|   |   | -               | 4NC          | XW1E-BV404M-R   |
| Illuminated <sup>1</sup><br> | 40mm Mushroom                             | 1NO             | 1NC          | XW1E-BV511M-R   |
|   |   | -               | 2NC          | XW1E-BV502M-R   |
|   |   | 2NO             | 2NC          | XW1E-BV522M-R   |
|   |   | 1NO             | 3NC          | XW1E-BV513M-R   |
|   |   | -               | 4NC          | XW1E-BV504M-R   |
| Illuminated <sup>1</sup><br> | 40mm Mushroom with built-in 24V AC/DC LED | 1NO             | 1NC          | XW1E-LV411Q4M-R |
|   |   | -               | 2NC          | XW1E-LV402Q4M-R |
|   |   | 2NO             | 2NC          | XW1E-LV422Q4M-R |
|   |   | 1NO             | 3NC          | XW1E-LV413Q4M-R |
|   |   | -               | 4NC          | XW1E-LV404Q4M-R |
| Illuminated <sup>1</sup><br> | 40mm Mushroom Push-ON LED <sup>2</sup>    | 1NO             | 2NC          | XW1E-TV412Q4M-R |

Smooth Button With Mechanical Indicator

| Style  | Operator Type | Monitor Contact  | Main Contact   | Part Number      |     |                  |
|--|---------------|--|--|------------------|-----|------------------|
| Non-Illuminated<br> | 38mm Mushroom | -  | 1NC  | XW1E-BV4TG01MR   |     |                  |
|  |               | -  | 2NC  | XW1E-BV4TG02MR   |     |                  |
|  |               | -  | 3NC  | XW1E-BV4TG03MR   |     |                  |
|  |               | -  | 4NC  | XW1E-BV4TG04MR   |     |                  |
|  |               | 1NO  | 1NC  | XW1E-BV4TG11MR   |     |                  |
|  |               | 1NO  | 2NC  | XW1E-BV4TG12MR   |     |                  |
|  |               | 1NO  | 3NC  | XW1E-BV4TG13MR   |     |                  |
|  |               | 2NO  | 4NC  | XW1E-BV4TG22MR   |     |                  |
|  |               | Illuminated<br> | 38mm Mushroom with built-in 24V AC/DC LED <sup>1</sup> | -                | 1NC | XW1E-LV4TG01Q4MR |
|  |               |  |  | -                | 2NC | XW1E-LV4TG02Q4MR |
| -  | 3NC           |  |  | XW1E-LV4TG03Q4MR |     |                  |
| -  | 4NC           |  |  | XW1E-LV4TG04Q4MR |     |                  |
| 1NO  | 1NC           |  |  | XW1E-LV4TG11Q4MR |     |                  |
| 1NO  | 2NC           |  |  | XW1E-LV4TG12Q4MR |     |                  |
| 1NO  | 3NC           |  |  | XW1E-LV4TG13Q4MR |     |                  |
| 2NO  | 2NC           |  |  | XW1E-LV4TG22Q4MR |     |                  |



- 1. The light is independent of the position of the switch, except for push-on LED type.
- 2. The light only operates when the switch is pressed as it is internally wired.

- Note: Pushlock pull/turn reset switches are locked when pressed, and reset when pulled or turned clockwise.
- 1. LED lamp is not removable.

XW Series EMO Switches

| Style  | NC Main Contact | NO Monitor Contact | Part Number        |
|--|-----------------|--------------------|--------------------|
| 40mm Mushroom<br> | 1NC             | -                  | XW1E-BV401M-RH-EMO |
|  | 2NC             | -                  | XW1E-BV402M-RH-EMO |
|  | 3NC             | -                  | XW1E-BV403M-RH-EMO |
|  | 4NC             | -                  | XW1E-BV404M-RH-EMO |
|  | 1NC             | 1NO                | XW1E-BV411M-RH-EMO |
|  | 2NC             | 1NO                | XW1E-BV412M-RH-EMO |
|  | 3NC             | 1NO                | XW1E-BV413M-RH-EMO |
|  | 2NC             | 2NO                | XW1E-BV422M-RH-EMO |

FB Enclosures with XW E-Stops

| Style   | Style  | NC Contact | NO Contact | Part Number       |
|---|--|------------|------------|-------------------|
|  | 40mm Push-lock Turn/Pull Reset Non-Illuminated | 2NC        | -          | FB1W-XW1E-BV402MR |
|   |  | 1NC        | 1NO        | FB1W-XW1E-BV411MR |
|   |  | 2NC        | 2NO        | FB1W-XW1E-BV422MR |
|   |  | 3NC        | 1NO        | FB1W-XW1E-BV413MR |
|   |  | 4NC        | -          | FB1W-XW1E-BV404MR |
|  | 40mm Push-lock Turn/Pull Reset Illuminated*    | 2NC        | -          | FB1W-XW1E-LV402MR |
|   |  | 1NC        | 1NO        | FB1W-XW1E-LV411MR |
|   |  | 2NC        | 2NO        | FB1W-XW1E-LV422MR |
|   |  | 3NC        | 1NO        | FB1W-XW1E-LV413MR |
|  | 60mm Push-lock Turn/Pull Reset Non-Illuminated | 2NC        | -          | FB1W-XW1E-BV502MR |
|   |  | 1NC        | 1NO        | FB1W-XW1E-BV511MR |
|   |  | 2NC        | 2NO        | FB1W-XW1E-BV522MR |
|   |  | 3NC        | 1NO        | FB1W-XW1E-BV513MR |
|   |  | 4NC        | -          | FB1W-XW1E-BV504MR |



For added safety, Switch Guards and Nameplates can be used with E-Stop Enclosures

- \*LED illumination voltage: 24V AC/DC

Overview

XW Series E-Stops

Interlock Switches

Enabling Switches

Safety Control

Light Curtains

AS-Interface Safety at Work

Contact Ratings

|                               |                       |                        |                        |       |      |      |
|-------------------------------|-----------------------|------------------------|------------------------|-------|------|------|
| Rated Insulation Voltage (Ui) |                       | 250V                   |                        |       |      |      |
| Rated Current (Ith)           |                       | 5A                     |                        |       |      |      |
| Rated Operating Voltage (Ue)  |                       | 30V                    | 125V                   | 250V  |      |      |
| Rated Operating Current       | Main Contacts (NC)    | AC 50/60Hz             | Resistive Load (AC-12) | -     | 5A   | 3A   |
|                               |                       |                        | Inductive Load (AC-15) | -     | 3A   | 1.5A |
|                               | DC                    | Resistive Load (DC-12) | 2A                     | 0.4A  | 0.2A |      |
|                               |                       | Inductive Load (DC-13) | 1A                     | 0.22A | 0.1A |      |
| Rated Operating Current       | Monitor Contacts (NO) | AC 50/60Hz             | Resistive Load (AC-12) | -     | 1.2A | 0.6A |
|                               |                       |                        | Inductive Load (AC-14) | -     | 0.6A | 0.3A |
|                               | DC                    | Resistive Load (DC-12) | 2A                     | 0.4A  | 0.2A |      |
|                               |                       | Inductive Load (DC-13) | 1A                     | 0.22A | 0.1A |      |

Mounting Hole Layout

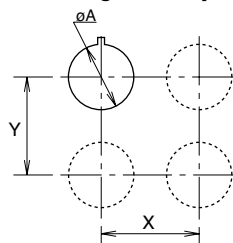

Measurements

| Size | øA                   | X & Y    |
|------|----------------------|----------|
| 40mm | 22.3 <sup>+0.4</sup> | 70mm min |

Panel Cutout

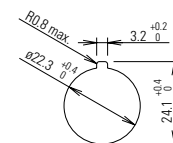

Minimum applicable load: 5V AC/DC, 1mA (reference value).  
The rated operating currents are measured at resistive/inductive load types specified in IEC 60947-5-1.

Illuminated Unit LED Ratings

| Operating Voltage | Current |
|-------------------|---------|
| 24V AC/DC ±10%    | 15mA    |

Depth Behind the Panel

| Depth (mm) | Description  |
|------------|--|
| 46.4       | with indicator, 1 - 4 contacts, both illuminated and non-illuminated |
| 48.7       | w/o indicator, 1 - 4 contacts, both illuminated and non-illuminated  |

Part Number Key

**XW1E - L V 4 TG 11 Q4MR**

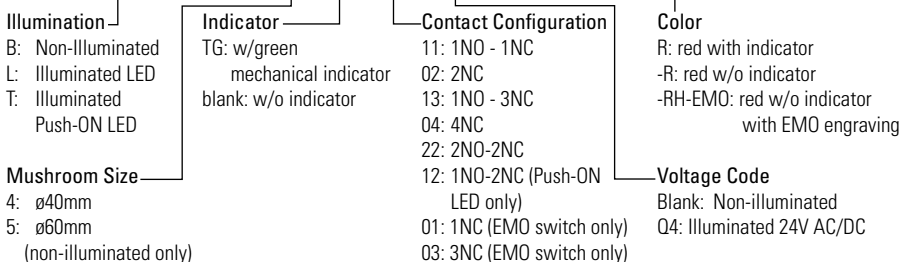

Terminal Arrangements (Bottom View)

**4NC**

Non-Illuminated

**1NO-3NC**

Non-Illuminated

**2NC**

Non-Illuminated

**1NO-1NC**

Non-Illuminated

**2NO-2NC**

Non-Illuminated

**1NO-2NC**

Push-ON

**Illuminated**

**Terminal Marking Description**

- Contact Type
  - 1-2: NC main contact
  - 3-4: NO monitor contact
- Contact Number (1-4)
  - Starting with the contact on TOP in a counterclockwise direction.
  - Note:
    - 1: contact on the TOP
    - 2: contact on the Left
    - 3: contact on the Bottom
    - 4: contact on the Right

(Example: 1NO-3NC contact)

Dimensions (mm)

**XW Standard Button Non-Illuminated Without Indicator (with terminal cover)**

**XW Standard Button LED Illuminated/ Push-ON Without Indicator (with terminal cover)**

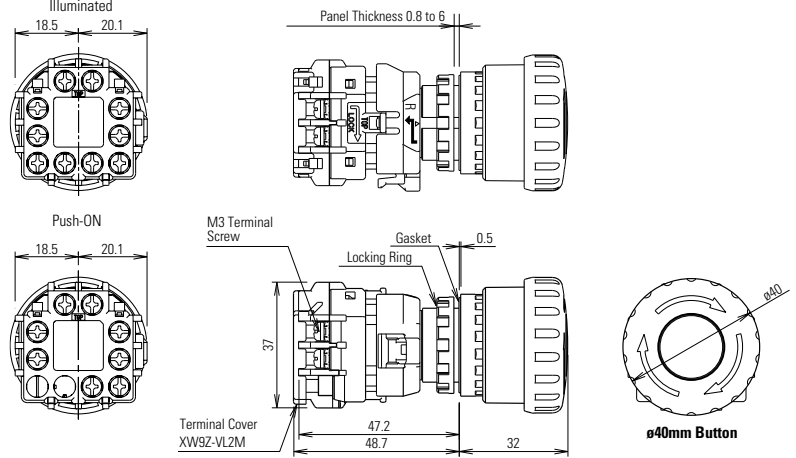
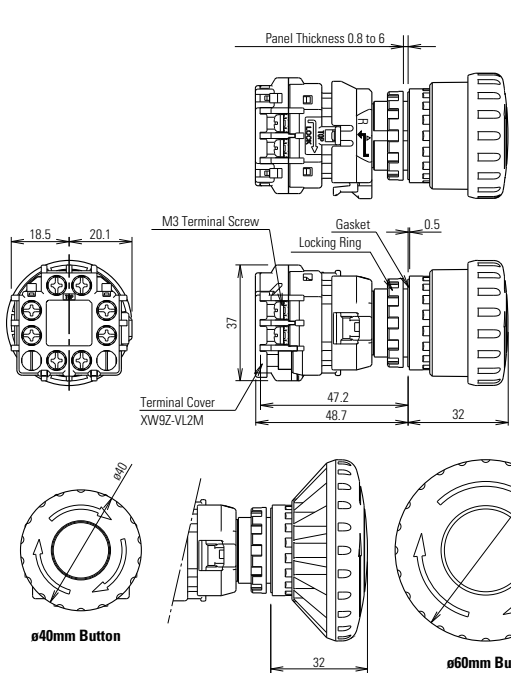

**XW Smooth Button Non-Illuminated With Indicator (with terminal cover)**

**XW Smooth Button LED Illuminated/ Push-ON With Indicator (with terminal cover)**

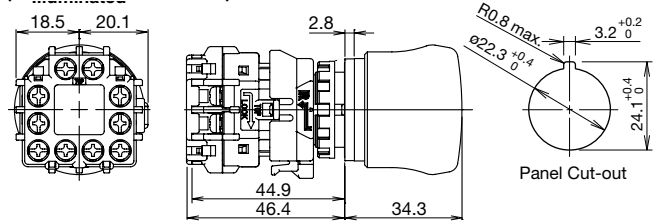
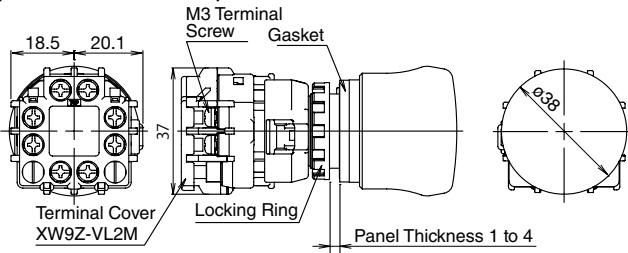

**EMO**

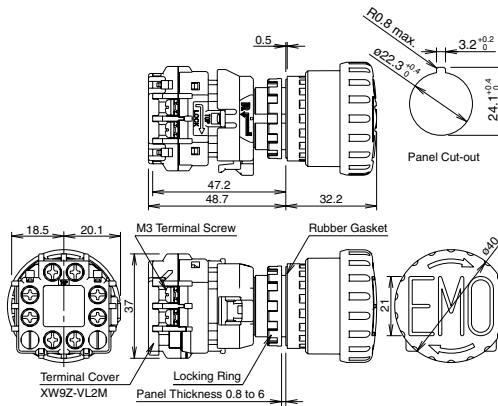
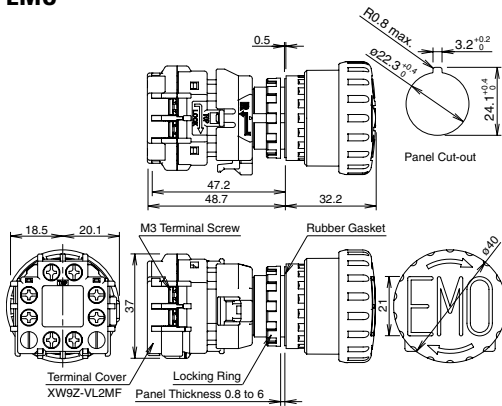

Overview

XW Series E-Stops

Interlock Switches

Enabling Switches



Safety Control

Light Curtains

AS-Interface Safety at Work



**Accessories: Terminal Covers**





| Appearance  | Description                      | Part Numbers |
|---|----------------------------------|--------------|
|  | Terminal Cover for contact block | XW9Z-VL2M    |
|  | IP20 Fingersafe Cover            | XW9Z-VL2MF   |

**Accessories: Nameplates**

| Appearance  | Legend           | Part Number | Inner Ø | Outer Ø |
|---|------------------|-------------|---------|---------|
|  | (blank)          | HWAV-0      | 22mm    | 60mm    |
|   | "Emergency Stop" | HWAV-27     | 22mm    | 60mm    |
|   | (blank)          | HWAV5-0     | 22mm    | 80mm    |
|   | "Emergency Stop" | HWAV5-27    | 22mm    | 80mm    |

 Use 60mm nameplates for 39mm and 40mm mushroom buttons and 80mm nameplates for 60mm mushroom buttons.

**Accessories: Shrouds**

| Appearance  | Part Numbers | E-Stop Types                       | Applicable Standards                           |
|---|--------------|------------------------------------|--|
|  | HW9Z-KG1     | 38mm, 40mm Mushroom Head           | SEMI S2-0703, 12.5.1 Compliant                 |
|  | HW9Z-KG2     | 38mm, 40mm, and 60mm Mushroom Head | SEMI S2-0703, 12.5.1 & SEMATECH Compliant      |
|  | HW9Z-KG3     | 38mm, 40mm Mushroom Head           | SEMI S2 Compliant (Approved by TUV)            |
|  | HW9Z-KG4     | 38mm, 40mm Mushroom Head           | SEMI S2 Compliant (Approved by TUV) & SEMATECH |

**Operating Instructions**

**Removing the Contact Block**

First unlock the operator button. Grab the bayonet ring ① and pull back the bayonet ring until the latch pin clicks ②, then turn the contact block counterclockwise and pull out ③.

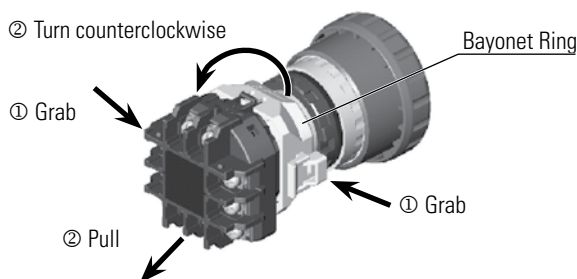

**Notes for removing the contact block**

1. When the contact block is removed, the monitor contact (NO contact) is closed.
2. While removing the contact block, do not exert excessive force, otherwise the switch may be damaged.
3. An LED lamp is built into the contact block for illuminated pushbuttons. When removing the contact block, pull the contact block straight to prevent damage to the LED lamp. If excessive force is exerted, the LED lamp may be damaged and fail to light.

**Panel Mounting**

Remove the locking ring from the operator and check that the rubber gasket is in place. Insert the operator from panel front into the panel hole. Face the side without thread on the operator with TOP marking upward, and tighten the locking ring using ring wrench MW9Z-T1 to a torque of 2.0 N·m maximum.

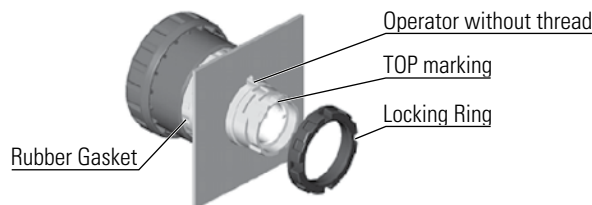

**Notes for Panel Mounting**

To prevent the XW emergency stop switch from rotating when resetting from the latched position, use of an anti-rotation ring (HW9Z-RL) or a nameplate is recommended.

**Installing the Contact Block**

First unlock the operator button. Align the small ▼ marking on the edge of the operator with the small ▲ marking on the yellow bayonet ring. Hold the contact block, not the bayonet ring. Press the contact block onto the operator and turn the contact block clockwise until the bayonet ring clicks.

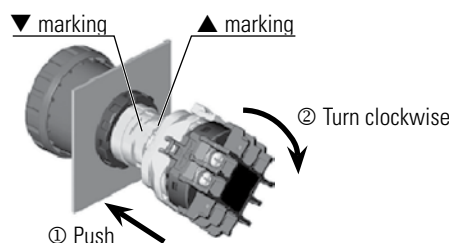

**Notes for installing the contact block**

Make sure that the bayonet ring is in the locked position. Check that the two projections on the bayonet ring are securely in place.

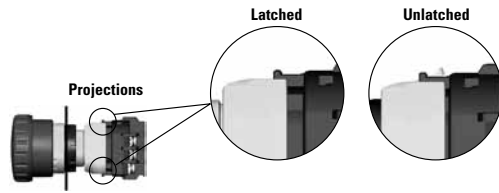

**Wiring**

The applicable wire size is 16 AWG maximum.

**Screw Terminal**

1. Wire thickness: AWG18 to 16
2. Tighten the M3 terminal screw to a tightening torque of 0.6 to 1.0 N·m.

**Installing and Removing Terminal Covers**

**XW9Z-VL2M**

To install the terminal cover, align the TOP marking on the terminal cover with the TOP marking on the contact block. Place the two projections on the bottom side of the contact block into the slots in the terminal cover. Press the terminal cover toward the contact block.

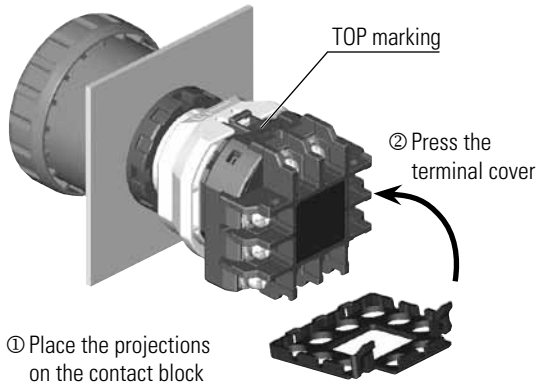

To remove the terminal cover, pull out the two latches on the top side of the terminal cover. Do not exert excessive force to the latches, otherwise the latches may break.

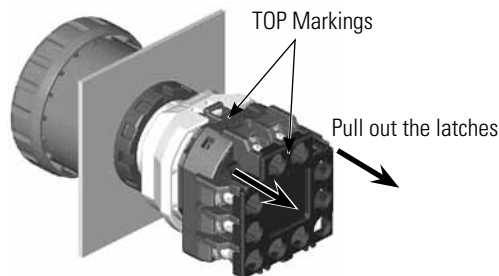

**IP20 Protection Terminal Cover XW9Z-VL2MF**

To install the IP20 protection cover, align the TOP marking on the cover with the TOP marking on the contact block, and press the cover toward the contact block.

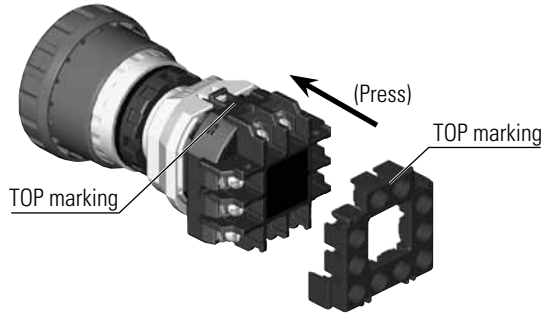

1. Once installed, the XW9Z-VL2MF cannot be removed.
2. The XW9Z-VL2MF cannot be installed after wiring.
3. With the XW9Z-VL2MF installed, crimping terminals cannot be used.
4. Make sure that the XW9Z-VL2MF is securely installed. IP20 protection cannot be achieved when installed loosely, and electric shocks may occur.

**Contact Bounce**

When the button is reset by pulling or turning, the NC main contacts will bounce. When pressing the button, the NO monitor contacts will bounce.

When designing a control circuit, take the contact bounce time into consideration (reference value: 20 ms).

**LED Illuminated Switches**

LED lamp is built into the contact block and cannot be replaced.

**Installing the Anti-rotation Ring HW9Z-RL**

Align the side without thread on the operator with TOP marking, the small marking on the anti-rotation ring, and the recess on the mounting panel.

