

## Connector - SACC-M12MS-5CON-PG 9 - 1500774

Please be informed that the data shown in this PDF Document is generated from our Online Catalog. Please find the complete data in the user's documentation. Our General Terms of Use for Downloads are valid (<http://phoenixcontact.com/download>)



Connector, Universal, 5-position, Plug straight M12, Coding: A, Screw connection, knurl material: Plastic, cable gland Pg9, external cable diameter 6 mm ... 8 mm

### Your advantages

- ✓ Safe use in the field, thanks to a high degree of protection
- ✓ Screw connection: proven connection technology for a large selection of different conductors



### Key Commercial Data

Packing unit	1 pc
GTIN	 4 017918 610517
GTIN	4017918610517
Weight per Piece (excluding packing)	19.300 g
Custom tariff number	85366990
Country of origin	Germany

### Technical data

#### Dimensions

Diameter housing	20 mm
Length	60 mm
External cable diameter	6 mm ... 8 mm
Stripping length of the sheath	20 mm
Stripping length of the individual wire	5 mm

#### Ambient conditions

Ambient temperature (operation)	-40 °C ... 85 °C (Plug / socket)
---------------------------------	----------------------------------

# Connector - SACC-M12MS-5CON-PG 9 - 1500774

## Technical data

### Ambient conditions

	-40 °C ... 85 °C (Plug / socket)
Degree of protection	IP67

### General

Note	NOTE: Observe the permissible bending radii when laying conductors, since the degree of protection may be put in jeopardy if the bending forces are too high. Alleviate mechanical loads upstream of the connector, e.g. by using cable ties.
Rated current at 40°C	4 A
Rated voltage	48 V AC 60 V DC
Number of positions	5
Insulation resistance	≥ 100 MΩ
Coding	A - standard
Standards/regulations	M12 connector IEC 61076-2-101
Signal type/category	Universal
Status display	No
Overvoltage category	II
Degree of pollution	3
Connection method	Screw connection
Conductor cross section	0.25 mm <sup>2</sup> ... 0.75 mm <sup>2</sup> (without ferrule) 0.14 mm <sup>2</sup> ... 0.75 mm <sup>2</sup> (with ferrule) 0.25 mm <sup>2</sup> ... 0.75 mm <sup>2</sup> (solid)
Conductor cross section AWG	24 ... 18 (without ferrule) 26 ... 20 (with ferrule)
Insertion/withdrawal cycles	≥ 50
Torque	0.4 Nm (M12 knurl) 0.2 Nm (Screw terminal blocks) 0.8 Nm ... 1 Nm (Pressure screw with sleeve housing)
Tightening torque	Screw plug insert with sleeve housing as far it will go

### Material

Flammability rating according to UL 94	HB
Contact material	CuZn
Contact surface material	CuSnZn
Contact carrier material	PA
Material of grip body	PA
Material, knurls	Plastic
Sealing material	NBR

# Connector - SACC-M12MS-5CON-PG 9 - 1500774

## Technical data

### Standards and Regulations

Connection in acc. with standard	CUL
Standards/specifications	M12 connector IEC 61076-2-101

### Environmental Product Compliance

REACH SVHC	Lead 7439-92-1
China RoHS	Environmentally Friendly Use Period = 50 years
	For details about hazardous substances go to tab "Downloads", Category "Manufacturer's declaration"

## Drawings

Schematic diagram

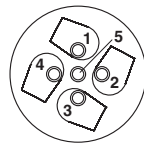

Cable connection side M12 (screw connection)

Schematic diagram

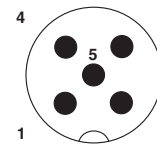

Pin assignment M12 male connector, 5-pos., A-coded, male side

Schematic diagram

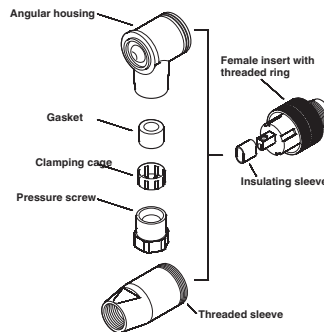

Male/Female M12

# Connector - SACC-M12MS-5CON-PG 9 - 1500774

Dimensional drawing

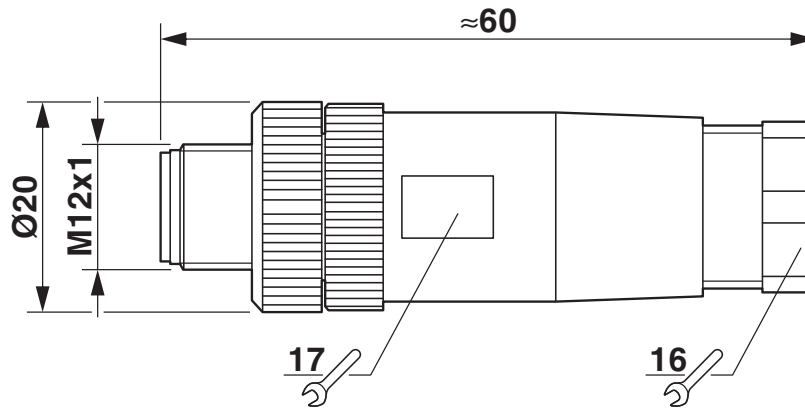

Plug, M12 x 1, straight

## Classifications

eCl@ss

eCl@ss 10.0.1	27440102
eCl@ss 11.0	27440102
eCl@ss 4.0	27260700
eCl@ss 4.1	27260700
eCl@ss 5.0	27260700
eCl@ss 5.1	27260700
eCl@ss 6.0	27279200
eCl@ss 7.0	27440104
eCl@ss 9.0	27440102

## ETIM

ETIM 2.0	EC001121
ETIM 3.0	EC002062
ETIM 4.0	EC002062
ETIM 6.0	EC002062
ETIM 7.0	EC002635

## UNSPSC

UNSPSC 6.01	31251501
UNSPSC 7.0901	31251501
UNSPSC 11	31251501
UNSPSC 12.01	31251501

# Connector - SACC-M12MS-5CON-PG 9 - 1500774

## Classifications

### UNSPSC

UNSPSC 13.2	39121413
UNSPSC 18.0	39121413
UNSPSC 19.0	39121413
UNSPSC 20.0	39121413
UNSPSC 21.0	39121413

## Approvals

### Approvals

#### Approvals

UL Recognized / cUL Recognized / cULus Recognized

#### Ex Approvals

### Approval details

UL Recognized		<a href="http://database.ul.com/cgi-bin/XYV/template/LISEXT/1FRAME/index.htm">http://database.ul.com/cgi-bin/XYV/template/LISEXT/1FRAME/index.htm</a>	FILE E 221474
Nominal voltage UN	125 V		
Nominal current IN	4 A		

cUL Recognized		<a href="http://database.ul.com/cgi-bin/XYV/template/LISEXT/1FRAME/index.htm">http://database.ul.com/cgi-bin/XYV/template/LISEXT/1FRAME/index.htm</a>	FILE E 221474
Nominal voltage UN	125 V		
Nominal current IN	4 A		

cULus Recognized	
------------------	---

## Connector - SACC-M12MS-5CON-PG 9 - 1500774

### Accessories

#### Accessories

##### Cable by the meter

Cable reel - SAC-5P-100,0-186/0,75 - 1535590



By the meter, Cable reel, PUR, black-gray RAL 7021, 5-wire, color single wire: Brown, white, blue, black, gray, cable length: 100 m

---

### Crimping tool

Crimping pliers - CRIMPFOX 6H - 1212046



Crimping pliers, for ferrules without insulating collar according to DIN 46228 Part 1 and ferrules with insulating collar according to DIN 46228 Part 4, 0.14 mm<sup>2</sup> ... 6 mm<sup>2</sup>, unlockable pressure lock, lateral entry

---

### Ferrule

Ferrule - A 0,25- 5 - 3202465



Ferrule, length: 5 mm, color: silver

---

### Protective cap

Sealing cap - PROT-M12 FS-PA-CHAIN - 1430873

M12 sealing cap made of plastic with fixing band, for sensor cables, for free M12 plugs



---

### Screwdriver tools

## Connector - SACC-M12MS-5CON-PG 9 - 1500774

### Accessories

Adapter insert - TSD-M SAC-BIT ADAPTER - 1212600



Adapter bit for TSD-M...torque tools, E6.3-1/4" drive with 4 mm hexagon to accommodate SAC bits

---

Tool - SACC BIT M12-D20 - 1208445



Nut for assembling M12 connectors for assembly with a knurl diameter of 20 mm, for 4 mm hexagonal drive

---

Screwdriver - SZF 1-0,6X3,5 - 1204517



Actuation tool, for ST terminal blocks, also suitable for use as a bladed screwdriver, size: 0.6 x 3.5 x 100 mm, 2-component grip, with non-slip grip

---

### Stripping tool

Stripping tool - WIREFOX SAC - 1212623



Stripping pliers, for halogen-free sensor/actuator cables (SAC cables), with PUR and PVC insulation, from Ø of 4.4 to 7 mm, any stripping length

---

### Torque tool

Torque screwdriver - TSD 04 SAC - 1208429



Torque screwdriver, with preset torque of 0.4 Nm and 4 mm hexagonal drive for M12 connectors

## Connector - SACC-M12MS-5CON-PG 9 - 1500774

### Accessories

---

Torque screwdriver - TSD-M 1,2NM - 1212224



Torque screw driver, accuracy as per EN ISO 6789 standard, adjustable from 0.3 - 1.2 Nm

---

---