









Now in more wattages and a new color!  
The small, light H17 high bay.

Now available in four models.

We've added two new power packages to the H17 family, making it even more versatile and ready to handle countless applications. All models have three selectable wattages and three CCTs.

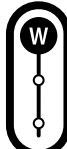

- 3000K
- 4000K
- 5000K

	H17S	H17	H17XL	H17XXL			
							
	100W 80W 60W		150W 120W 100W		240W 200W 150W		500W 400W 300W
	up to 15,000 lumens	up to 22,000 lumens	up to 37,000 lumens	up to 79,000 lumens			



100,000 HOUR  
LED LIFESPAN



480 VOLT  
OPTION



5-YEAR LIMITED  
WARRANTY

RAB's warranty is  
subject to all terms  
and conditions found at  
rablighting.com/warranty

## It's dropped a few sizes.

The newest generation of the H17 is smaller and lighter than its already-compact original. The smallest body is less than a foot in diameter, and the entire family delivers incredibly high output, replacing up to 1000W MH while boasting even higher efficacy than before... all at a rock-bottom price.

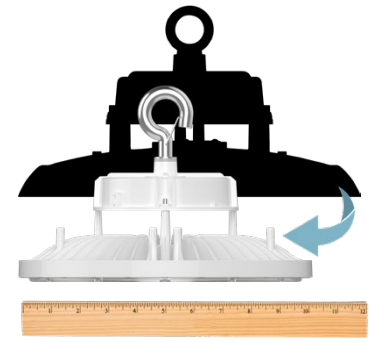

## Even MORE control.

The H17 includes an expansion port that makes it easy to screw on standard or Lightcloud Blue-enabled PIR and microwave sensors, which can be configured to adjust brightness and hold time, saving additional energy and costs. A remote is also available for an additional level of control.

### Lightcloud®



PIR Sensor Kit: [PIR40](#)

Microwave Sensor Kit: [MVS50](#)

Remote (for standard PIR and MVS Sensors only): [MSR1](#)

Lightcloud Blue-Enabled PIR Sensor Kit: [PIR40/LCB](#)

Lightcloud Blue-Enabled MVS Sensor Kit: [MVS50/LCB](#)

## Accessories galore.

Various reflectors, refractors, lenses, and wire guards are available for the H17 family, in addition to mounting accessories and battery backups.

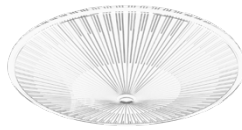

*Can only be used with the polycarbonate refractor. May not be combined with the aluminum refractor.*

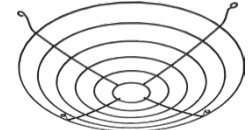

*Can only be mounted directly to fixture.*



## Ordering Matrix

### Field-Adjustable Models

Product Family	Wattage	Mounting	Color Temp	Finish	Voltage
H17					
S Blank XL XXL	100/80/60W Adjustable 150/120/100W Adjustable 240/200/150W Adjustable 500/400/300W Adjustable	Blank Hook	Blank 5000/4000/3000K Adjustable	Blank White Black	Blank /480 0-10V Dimming, 120-277V 0-10V Dimming, 480V *

### Static Models

Product Family	Wattage	Mounting	Color Temp	Finish	Voltage
H17					/480
Blank XL	150W 240W	Blank Hook	Blank N 5000K 4000K	Blank B White Black	/480 0-10V Dimming, 480V

\*Only available for XXL model