

# SD50 Status Display Product Manual



Original Instructions

p/n: 242994 Rev. C

21-Feb-25

© Banner Engineering Corp. All rights reserved. [www.bannerengineering.com](http://www.bannerengineering.com)

# Contents

<b>Chapter 1 Features</b> .....	<b>3</b>
Models .....	3
<b>Chapter 2 Wiring</b> .....	<b>4</b>
<b>Chapter 3 Pro Editor Configuration for the SD50 Pro LED Status Display</b> .....	<b>5</b>
Full Preview Connection (Required).....	6
Discrete Control.....	6
Basic I/O State .....	6
Advanced I/O State.....	7
I/O Block I/O State .....	7
Sequence Mode .....	8
Timer Mode.....	8
Counter Mode.....	9
Measure Mode.....	9
Factory Reset .....	10
Display Settings.....	10
<b>Chapter 4 Specifications</b> .....	<b>12</b>
FCC Part 15 Class A for Unintentional Radiators .....	13
Industry Canada ICES-003(A).....	13
Dimensions .....	13
<b>Chapter 5 Accessories</b> .....	<b>14</b>
Cordsets .....	14
Mounting Brackets.....	14
<b>Chapter 6 Product Support and Maintenance</b> .....	<b>16</b>
UTF-8 Encoding Table and Unicode Characters .....	16
Clean with Mild Detergent and Water .....	20
Repairs .....	20
Contact Us.....	21
Banner Engineering Corp Limited Warranty .....	21

Chapter Contents

Models ..... 3

# Chapter 1 Features

*Provide More Status Information in the Most Helpful Locations*

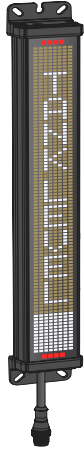

- Easily configurable, versatile display can be installed nearly anywhere, making it a simple yet powerful alternative to complex HMIs and other displays
- Great for displaying takt time, equipment status, assembly sequences, counts, and measurements where they are most useful
- Discrete and IO-Link models integrate into many different systems and applications, especially Banner sensing, safety, and monitoring solutions
- Quick and easy configuration—simply define the desired text and call it via discrete control or process data
- Bright white LED display and multicolored status LEDs legible from 10 meters away inform operators about exactly what is going on so they can respond quickly and accurately
- IP65-rated polycarbonate housing resists impact and condensation to provide clear communication in challenging and changing environmental conditions

## Models

*Model Key*

Series	Height	Style	Display Length	Display Text Color	Control	Connector <sup>(1)</sup>
SD	50	P	300	W	D15	QP
Status Display	50 mm height	P = Pro	300 = 300 mm	W = White	D15 = Discrete 15 states	QP = 150 mm (6 in) PVC-jacketed cable with a 5-pin M12 male quick-disconnect connector

<sup>(1)</sup> Models with a quick-disconnect connector require a mating cordset.

Chapter Contents

# Chapter 2 Wiring

*SD50 Wiring*

5-Pin Male M12 Pinout	Pinout Key and Wiring
 <p>The diagram shows a top-down view of a 5-pin male M12 connector. It consists of a circular housing with five pins protruding from the center. The pins are arranged in a circular pattern. The pins are numbered 1 through 5. Pin 1 is at the top, pin 2 is at the top-left, pin 3 is at the bottom-left, pin 4 is at the bottom-right, and pin 5 is at the top-right.</p>	<ol style="list-style-type: none"><li>1. Brown - Input 1</li><li>2. White - Input 3</li><li>3. Blue - DC Common</li><li>4. Black - Input 2</li><li>5. Gray - Input 4</li></ol>

Chapter Contents

Full Preview Connection (Required)..... 6  
 Discrete Control..... 6  
 Sequence Mode ..... 8  
 Timer Mode ..... 8  
 Counter Mode..... 9  
 Measure Mode ..... 9  
 Factory Reset ..... 10  
 Display Settings..... 10

# Chapter 3 Pro Editor Configuration for the SD50 Pro LED Status Display



Banner's Pro Editor software offers an easy way to configure Pro Series-enabled indication, touch, and illumination devices, allowing users full control of device states and device logic modes. The easy-to-use configuration software provides a variety of tools and capabilities to solve a wide range of applications such as indicating machine status or warm-up time, indicating unique steps in an assembly process, or incorporating status information into touch buttons.

Setup any Pro Series-enabled device using the free Pro Editor software, available for download at [www.bannerengineering.com/proeditor](http://www.bannerengineering.com/proeditor).

## Full Preview Connection (Required)

The full preview connection must be used for the SD50 Status Display.

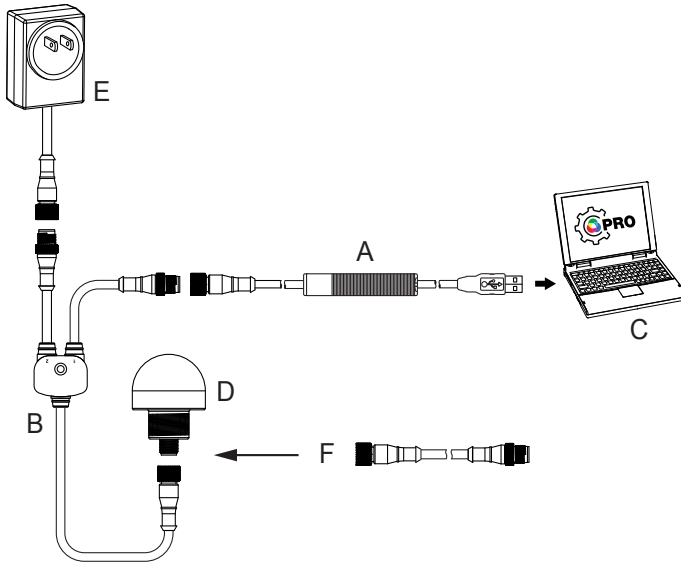

A = Pro Converter Cable (MQDC-506-USB)  
 B = Splitter (CSB-M1251FM1251M)  
 C = PC running Pro Editor software  
 D = Any Banner Pro Series-enabled device (K50 shown)  
 E = Power Supply (PSW-24-1, PSW-24-2, or PSD-24-4)  
 F = 8-Pin to 5-Pin Double-Ended Cordset (MQDC-801-5M-PRO),  
 required for 8-Pin models

## Discrete Control

Selecting the Discrete Control tile displays three I/O State tiles:

- Basic
- Advanced
- I/O Block



### Basic I/O State

Basic four-state control. Configurations made in Basic I/O State assign one wire to one state, with the following override control:

- Pin 1 (Brown) overrides Pin 4 (Black)
- Pin 2 (White) overrides Pins 1 and 4 (Brown and Black)
- Pin 5 (Gray) overrides Pins 1, 2, and 4 (Brown, White, and Black)



### Advanced I/O State

Advanced, default I/O state, with fifteen state options for maximum configuration ability. Configurations made in Advanced I/O State assign binary wiring combinations of all valid inputs to each state. Both the indication LEDs and the display text can be programmed for each of the states.

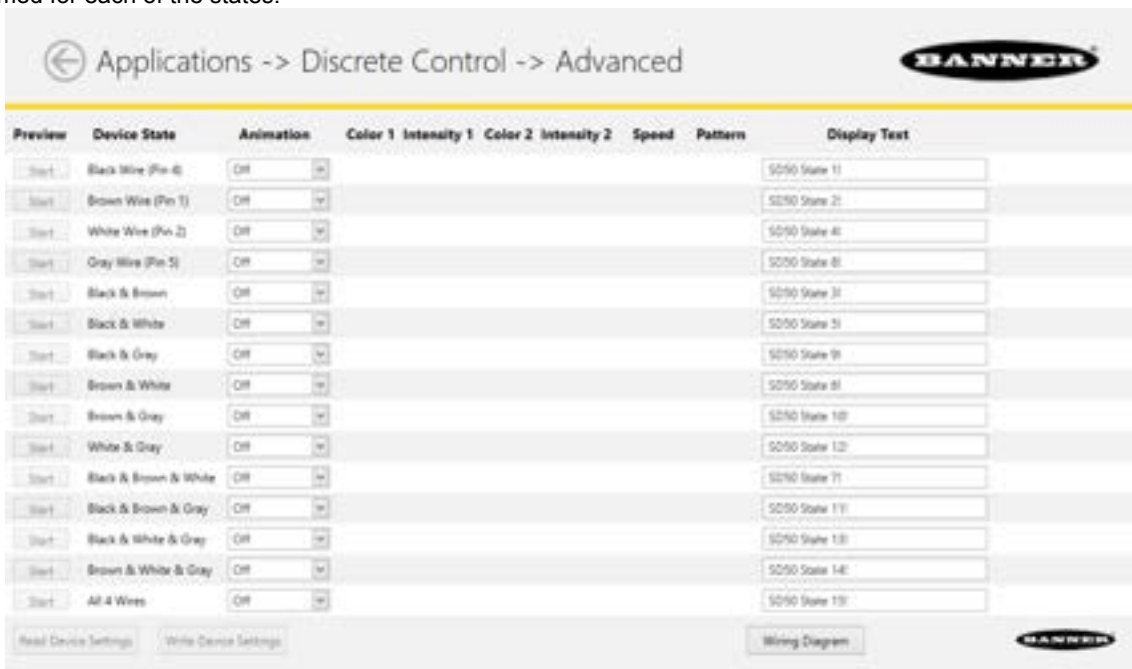

### I/O Block I/O State

Three-state control for use with I/O block. Configurations made in I/O Block assign state to the black, white, and combination of black and white wires for use with the I/O blocks, for which power (brown) and common (blue) are always on for five-pin connections.



## Sequence Mode

Sequence Mode allows up to sixteen states that a single input can control. A pulse on the input wire moves the SD50 to the next state.



<b>Reset State Input</b>	Choose the desired input wire to restart the SD50 to the First Animation as chosen in the dropdown menu.
<b>Next State Input</b>	Choose the desired input wire to move SD50 to the next state in the series until the Last Animation is reached.
<b>First Animation</b>	Choose the initial state to display as the sequence is initiated.
<b>Last Animation</b>	Choose the final state to include in the sequence.

## Timer Mode

Set a total time and up to four thresholds. Start and stop the timer counting up or down with discrete control. Colors change across threshold values.

Timer Mode uses the SD50 as a timer, counting up or down.



<b>Count Seconds</b>	The total time of the timer.
<b>Direction</b>	Up: Counts up from zero to Count Seconds. Down: Counts down from Count Seconds to zero.
<b>Reset Input</b>	Enable or disable the input wire to reset the timer to the initial value.
<b>Auto Restart</b>	The timer loops back to the original value automatically when it reaches its final value.

<b>Bar Graph Orientation</b>	Determine the starting side of the bar graph. The direction of the graph is determined by the direction of the timer.
<b>Decimal Places</b>	Determine the number of decimal places displayed on the Count Value.
<b>Display Graph Only</b>	Only display the bar graph, and not the numerical Count Value.
<b>Display Bar Graph</b>	Display the bar graph across the full display.
<b>Display Slim Bar Graph</b>	Display the bar graph as a single line of LEDs.
<b>Display Level as Time</b>	Display the time in HH:MM:SS format without data labels.

Continued on page 9



Continued from page 8

<b>Data Label</b>	Text that displays before the Count Value.
<b>Value Label</b>	Text that displays after the Count Value to indicate the units displayed. This can be up to three characters.
<b>Standard Settings</b>	Reset the SD50 to predetermined settings.

## Counter Mode

Set a total count and up to four thresholds. Discrete, rising edge pulses count up or down. Colors change across threshold values.

Counter Mode uses the SD50 as a counter.



<b>Pulses</b>	Determine the number of counts that are either counted up to or counted down from, depending on the chosen direction.
<b>Direction</b>	Up: Counts from zero to Pulses. Down: Counts from Pulses to zero.
<b>Reset Input</b>	Enable or disable the input wire to reset the count to the initial value.

<b>Bar Graph Orientation</b>	Determine the starting side of the bar graph. The direction of the graph is determined by the direction of the timer.
<b>Decimal Places</b>	Determine the number of decimal places displayed on the Count Value.
<b>Display Graph Only</b>	Only display the bar graph, and not the numerical Count Value.
<b>Display Bar Graph</b>	Display the bar graph across the full display.
<b>Display Slim Bar Graph</b>	Display the bar graph as a single line of LEDs.
<b>Data Label</b>	Text that displays before the Count Value.
<b>Value Label</b>	Text that displays after the Count Value to indicate the units displayed. This can be up to three characters.
<b>Standard Settings</b>	Reset the SD50 to predetermined settings.

## Measure Mode

Measure Mode uses the SD50 to display a measurement as either PWM control or PFM control.



<b>PWM/PFM</b>	PWM: Pulse-Width Modulation. PFM: Pulse-Frequency Modulation.
<b>PWM/PFM Low</b>	The lowest frequency of the input range.
<b>PWM/PFM High</b>	The highest frequency of the input range.
<b>Filter Level</b>	The level of filtering used to minimize the effects of noise on the output.
<b>Hysteresis Level</b>	The level of lag between the measurement thresholds to minimize the flickering at switch points.
<b>Output Scale Value Low</b>	The low-end value of the output translated from the input frequency.
<b>Output Scale Value High</b>	The high-end value of the output translated from the input frequency.

<b>Bar Graph Orientation</b>	Determine the starting side of the bar graph. The direction of the graph is determined by the direction of the timer.
<b>Decimal Places</b>	Determine the number of decimal places displayed on the Count Value.
<b>Display Graph Only</b>	Only display the bar graph, and not the numerical Count Value.
<b>Display Bar Graph</b>	Display the bar graph across the full display.
<b>Display Slim Bar Graph</b>	Display the bar graph as a single line of LEDs.
<b>Display Level as Time</b>	Display the time in HH:MM:SS format without data labels.
<b>Data Label</b>	Text that displays before the Count Value.
<b>Value Label</b>	Text that displays after the Count Value to indicate the units displayed. This can be up to three characters.
<b>Standard Settings</b>	Reset the SD50 to predetermined settings.

## Factory Reset

Restore the SD50 to default settings.

## Display Settings

Display Settings are a type of advanced settings that are accessible across all Applications.

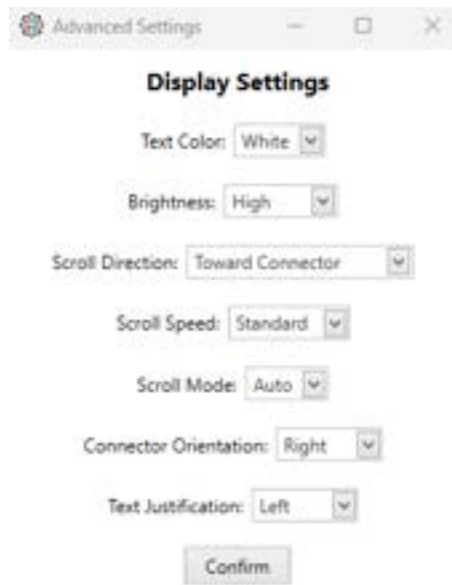

<b>Text Color</b>	Configure the primary text color as either white or black.
<b>Brightness</b>	Control the brightness of the display text.
<b>Scroll Direction</b>	Scroll the display text either toward or away from the connector.
<b>Scroll Speed</b>	Control the speed the display text scrolls.
<b>Scroll Mode</b>	Auto: Scrolls if the number of characters is greater than sixteen. Off: Does not scroll the display text. On: Scrolls the display text regardless of the number of characters.
<b>Connector Orientation</b>	Determine the orientation of the connector when installed. The display text automatically adjusts to the correct orientation.
<b>Text Justification</b>	Control the alignment of the display text: left, right, or center.

Chapter Contents

FCC Part 15 Class A for Unintentional Radiators..... 13  
 Industry Canada ICES-003(A)..... 13  
 Dimensions..... 13

# Chapter 4 Specifications

**Supply Voltage**

12 V DC to 30 V DC

Use only with a suitable Class 2 power supply (UL) or SELV power supply (CE)

**Supply Current**

550 mA max. at 12 V DC

260 mA max. at 24 V DC

210 mA max. at 30 V DC

**Connections**

150 mm (6 in) PVC-jacketed cable with a 5-pin M12 male quick-disconnect connector

Models with a quick-disconnect connector require a mating cordset

Do not spray cable with high-pressure sprayer or cable damage will result

**Operating Temperature**

-20 °C to +50 °C (-4 °F to +122 °F)

**Storage Temperature**

-40 °C to +70 °C (-40 °F to +158 °F)

**Environmental Rating**

Rated IP65

Suitable for damp locations per UL 2108

**Vibration and Mechanical Shock**

Meets IEC 60068-2-6 requirements (Vibration: 10 Hz to 55 Hz, 1.0 mm amplitude, 5 minutes sweep, 30 minutes dwell)

Meets IEC 60068-2-27 requirements (Shock: 15G 11 ms duration, half sine wave)

**Construction**

Black polycarbonate housing and end caps

Internal silicone-encapsulated LEDs

Smoky polycarbonate window

**Character Limit**

Discrete Control: 29 characters

All other Modes: 32 characters

**Animations**

Animation	Description
Off	Light is off
Steady	Color 1 is solid on at a defined intensity
Flash	Color 1 flashes at a defined speed, color intensity, and pattern (Normal, Strobe, Three Pulse, SOS, or Random)
Two Color Flash	Color 1 and Color 2 flash alternately at defined speed, color intensities, and pattern (Normal, Strobe, Three Pulse, SOS, or Random)
50/50	Color 1 and Color 2 are solid at a defined intensity
50/50 Flash	Color 1 and Color 2 flash at a defined speed, color intensity, and pattern (Normal, Strobe, Three Pulse, SOS, or Random)
Intensity Sweep	Color 1 repeatedly increases and decreases intensity between 0% to 100% at defined speed and color intensity
Two Color Sweep	Color 1 and Color 2 define the end values of a line across the color gamut. The light continuously displays a color by moving along the line at the defined speed and color intensities

**Required Overcurrent Protection**



**WARNING:** Electrical connections must be made by qualified personnel in accordance with local and national electrical codes and regulations.

Overcurrent protection is required to be provided by end product application per the supplied table.

Overcurrent protection may be provided with external fusing or via Current Limiting, Class 2 Power Supply.

Supply wiring leads < 24 AWG shall not be spliced.

For additional product support, go to [www.bannerengineering.com](http://www.bannerengineering.com).

Supply Wiring (AWG)	Required Overcurrent Protection (A)	Supply Wiring (AWG)	Required Overcurrent Protection (A)
20	5.0	26	1.0
22	3.0	28	0.8
24	1.0	30	0.5

**Mounting**

M5 and 1/4-20 compatible end caps (not included)

Clip brackets for mounting are available

## FCC Part 15 Class A for Unintentional Radiators

This equipment has been tested and found to comply with the limits for a Class A digital device, pursuant to Part 15 of the FCC Rules. These limits are designed to provide reasonable protection against harmful interference when the equipment is operated in a commercial environment. This equipment generates, uses, and can radiate radio frequency energy and, if not installed and used in accordance with the instruction manual, may cause harmful interference to radio communications. Operation of this equipment in a residential area is likely to cause harmful interference in which case the user will be required to correct the interference at his own expense.

(Part 15.21) Any changes or modifications not expressly approved by the party responsible for compliance could void the user's authority to operate this equipment.

## Industry Canada ICES-003(A)

This device complies with CAN ICES-3 (A)/NMB-3(A). Operation is subject to the following two conditions: 1) This device may not cause harmful interference; and 2) This device must accept any interference received, including interference that may cause undesired operation.

Cet appareil est conforme à la norme NMB-3(A). Le fonctionnement est soumis aux deux conditions suivantes : (1) ce dispositif ne peut pas occasionner d'interférences, et (2) il doit tolérer toute interférence, y compris celles susceptibles de provoquer un fonctionnement non souhaité du dispositif.

## Dimensions

All measurements are listed in millimeters [inches], unless noted otherwise. The measurements provided are subject to change.

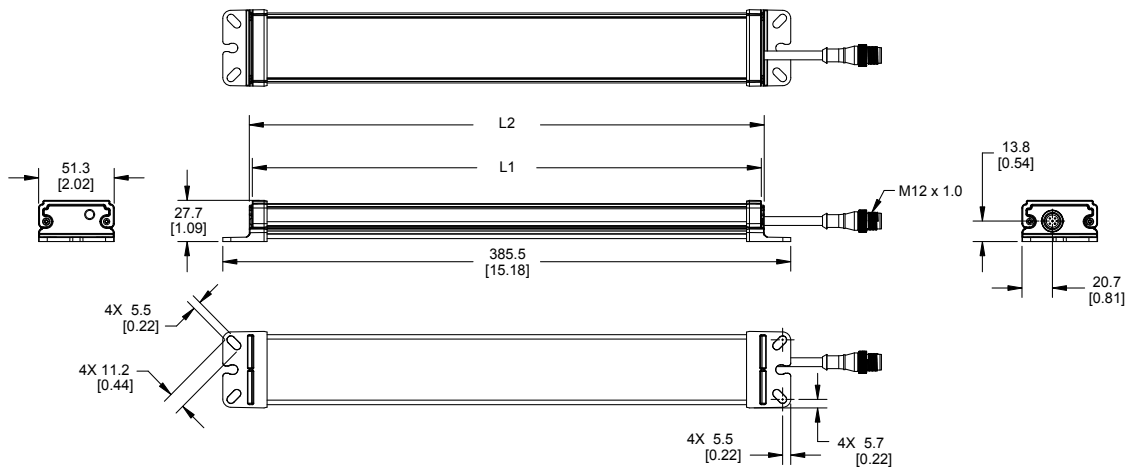

Models	L1	L2
SD50..300..	300 mm (11.81 in)	325 mm (12.8 in)

Chapter Contents

Cordsets ..... 14  
 Mounting Brackets..... 14

# Chapter 5 Accessories

## Cordsets

All measurements are listed in millimeters [inches], unless noted otherwise. The measurements provided are subject to change.

5-pin Double-Ended M12 Female to M12 Male Cordsets				
Model	Length	Dimensions (mm)	Pinouts	
BC-M12F5-M12M5-22-1	1 m (3.28 ft)		Female	1 = Brown 2 = White 3 = Blue 4 = Black 5 = Gray
BC-M12F5-M12M5-22-2	2 m (6.56 ft)			
BC-M12F5-M12M5-22-5	5 m (16.4 ft)			
BC-M12F5-M12M5-22-8	8 m (26.25 ft)			
BC-M12F5-M12M5-22-10	10 m (30.81 ft)			
BC-M12F5-M12M5-22-15	15 m (49.2 ft)		Male	

5-pin Double-Ended M12 Female Right-Angle to M12 Male Right-Angle Cordsets				
Model	Length	Dimensions (mm)	Pinouts	
BC-M12F5A-M12M5A-22-1	1 m (3.28 ft)		Female	1 = Brown 2 = White 3 = Blue 4 = Black 5 = Gray
BC-M12F5A-M12M5A-22-2	2 m (6.56 ft)			
BC-M12F5A-M12M5A-22-5	5 m (16.4 ft)			
BC-M12F5A-M12M5A-22-8	8 m (26.25 ft)			
BC-M12F5A-M12M5A-22-10	10 m (30.81 ft)			
BC-M12F5A-M12M5A-22-15	15 m (49.2 ft)		Male	

## Mounting Brackets

<p><b>LMBSD50</b></p> <ul style="list-style-type: none"> <li>• Metal mounting bracket kit</li> <li>• Hardware included</li> </ul>	
---	--

**LMBSD50MAG**

- Magnetic mounting bracket kit
- Up to 7.26 kg (16 lb) pull
- Hardware included

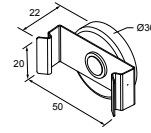

**LMBSD50-180S**

- Metal mounting bracket kit with 180-degree rotation
- Stainless steel
- Hardware included

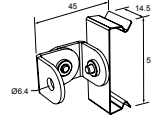

**LMBSD50-180SMAG**

- Magnetic mounting bracket kit with 180-degree rotation
- Stainless steel
- Up to 7.26 kg (16 lb) pull
- Hardware included

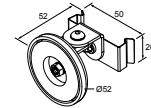

## Chapter Contents

UTF-8 Encoding Table and Unicode Characters.....	16
Clean with Mild Detergent and Water.....	20
Repairs .....	20
Contact Us.....	21
Banner Engineering Corp Limited Warranty.....	21

## Chapter 6 Product Support and Maintenance

### UTF-8 Encoding Table and Unicode Characters

Unicode Code Point	Character	UTF-8 (hex.)	Name
U+0020		20	SPACE
U+0021	!	21	EXCLAMATION MARK
U+0022	"	22	QUOTATION MARK
U+0023	#	23	NUMBER SIGN
U+0024	\$	24	DOLLAR SIGN
U+0025	%	25	PERCENT SIGN
U+0026	&	26	AMPERSAND
U+0027	'	27	APOSTROPHE
U+0028	(	28	LEFT PARENTHESIS
U+0029	)	29	RIGHT PARENTHESIS
U+002A	*	2a	ASTERISK
U+002B	+	2b	PLUS SIGN
U+002C	,	2c	COMMA
U+002D	-	2d	HYPHEN-MINUS
U+002E	.	2e	FULL STOP
U+002F	/	2f	SOLIDUS
U+0030	0	30	DIGIT ZERO
U+0031	1	31	DIGIT ONE
U+0032	2	32	DIGIT TWO
U+0033	3	33	DIGIT THREE
U+0034	4	34	DIGIT FOUR
U+0035	5	35	DIGIT FIVE
U+0036	6	36	DIGIT SIX
U+0037	7	37	DIGIT SEVEN
U+0038	8	38	DIGIT EIGHT
U+0039	9	39	DIGIT NINE
U+003A	:	3a	COLON
U+003B	;	3b	SEMICOLON
U+003C	<	3c	LESS-THAN SIGN
U+003D	=	3d	EQUALS SIGN
U+003E	>	3e	GREATER-THAN SIGN

Continued on page 17



Continued from page 16

Unicode Code Point	Character	UTF-8 (hex.)	Name
U+003F	?	3f	QUESTION MARK
U+0040	@	40	COMMERCIAL AT
U+0041	A	41	LATIN CAPITAL LETTER A
U+0042	B	42	LATIN CAPITAL LETTER B
U+0043	C	43	LATIN CAPITAL LETTER C
U+0044	D	44	LATIN CAPITAL LETTER D
U+0045	E	45	LATIN CAPITAL LETTER E
U+0046	F	46	LATIN CAPITAL LETTER F
U+0047	G	47	LATIN CAPITAL LETTER G
U+0048	H	48	LATIN CAPITAL LETTER H
U+0049	I	49	LATIN CAPITAL LETTER I
U+004A	J	4a	LATIN CAPITAL LETTER J
U+004B	K	4b	LATIN CAPITAL LETTER K
U+004C	L	4c	LATIN CAPITAL LETTER L
U+004D	M	4d	LATIN CAPITAL LETTER M
U+004E	N	4e	LATIN CAPITAL LETTER N
U+004F	O	4f	LATIN CAPITAL LETTER O
U+0050	P	50	LATIN CAPITAL LETTER P
U+0051	Q	51	LATIN CAPITAL LETTER Q
U+0052	R	52	LATIN CAPITAL LETTER R
U+0053	S	53	LATIN CAPITAL LETTER S
U+0054	T	54	LATIN CAPITAL LETTER T
U+0055	U	55	LATIN CAPITAL LETTER U
U+0056	V	56	LATIN CAPITAL LETTER V
U+0057	W	57	LATIN CAPITAL LETTER W
U+0058	X	58	LATIN CAPITAL LETTER X
U+0059	Y	59	LATIN CAPITAL LETTER Y
U+005A	Z	5a	LATIN CAPITAL LETTER Z
U+005B	[	5b	LEFT SQUARE BRACKET
U+005C	\	5c	REVERSE SOLIDUS
U+005D	]	5d	RIGHT SQUARE BRACKET
U+005E	^	5e	CIRCUMFLEX ACCENT
U+005F	_	5f	LOW LINE
U+0060	`	60	GRAVE ACCENT
U+0061	a	61	LATIN SMALL LETTER A
U+0062	b	62	LATIN SMALL LETTER B
U+0063	c	63	LATIN SMALL LETTER C
U+0064	d	64	LATIN SMALL LETTER D
U+0065	e	65	LATIN SMALL LETTER E
U+0066	f	66	LATIN SMALL LETTER F
U+0067	g	67	LATIN SMALL LETTER G
U+0068	h	68	LATIN SMALL LETTER H

Continued on page 18

Continued from page 17

Unicode Code Point	Character	UTF-8 (hex.)	Name
U+0069	i	69	LATIN SMALL LETTER I
U+006A	j	6a	LATIN SMALL LETTER J
U+006B	k	6b	LATIN SMALL LETTER K
U+006C	l	6c	LATIN SMALL LETTER L
U+006D	m	6d	LATIN SMALL LETTER M
U+006E	n	6e	LATIN SMALL LETTER N
U+006F	o	6f	LATIN SMALL LETTER O
U+0070	p	70	LATIN SMALL LETTER P
U+0071	q	71	LATIN SMALL LETTER Q
U+0072	r	72	LATIN SMALL LETTER R
U+0073	s	73	LATIN SMALL LETTER S
U+0074	t	74	LATIN SMALL LETTER T
U+0075	u	75	LATIN SMALL LETTER U
U+0076	v	76	LATIN SMALL LETTER V
U+0077	w	77	LATIN SMALL LETTER W
U+0078	x	78	LATIN SMALL LETTER X
U+0079	y	79	LATIN SMALL LETTER Y
U+007A	z	7a	LATIN SMALL LETTER Z
U+007B	{	7b	LEFT CURLY BRACKET
U+007C		7c	VERTICAL LINE
U+007D	}	7d	RIGHT CURLY BRACKET
U+007E	~	7e	TILDE
U+00A0		c2 a0	NO-BREAK SPACE
U+00A1	¡	c2 a1	INVERTED EXCLAMATION MARK
U+00A2	¢	c2 a2	CENT SIGN
U+00A3	£	c2 a3	POUND SIGN
U+00A4	¤	c2 a4	CURRENCY SIGN
U+00A5	¥	c2 a5	YEN SIGN
U+00A6	¦	c2 a6	BROKEN BAR
U+00A7	§	c2 a7	SECTION SIGN
U+00A8	¨	c2 a8	DIAERESIS
U+00A9	©	c2 a9	COPYRIGHT SIGN
U+00AA	ª	c2 aa	FEMININE ORDINAL INDICATOR
U+00AB	«	c2 ab	LEFT-POINTING DOUBLE ANGLE QUOTATION MARK
U+00AC	¬	c2 ac	NOT SIGN
U+00AD		c2 ad	SOFT HYPHEN
U+00AE	®	c2 ae	REGISTERED SIGN
U+00AF	–	c2 af	MACRON
U+00B0	°	c2 b0	DEGREE SIGN
U+00B1	±	c2 b1	PLUS-MINUS SIGN
U+00B2	²	c2 b2	SUPERSCRIPT TWO
U+00B3	³	c2 b3	SUPERSCRIPT THREE

Continued on page 19

Continued from page 18

Unicode Code Point	Character	UTF-8 (hex.)	Name
U+00B4	´	c2 b4	ACUTE ACCENT
U+00B5	µ	c2 b5	MICRO SIGN
U+00B6	¶	c2 b6	PILCROW SIGN
U+00B7	·	c2 b7	MIDDLE DOT
U+00B8	¸	c2 b8	CEDILLA
U+00B9	¹	c2 b9	SUPERSCRIPT ONE
U+00BA	º	c2 ba	MASCULINE ORDINAL INDICATOR
U+00BB	»	c2 bb	RIGHT-POINTING DOUBLE ANGLE QUOTATION MARK
U+00BC	¼	c2 bc	VULGAR FRACTION ONE QUARTER
U+00BD	½	c2 bd	VULGAR FRACTION ONE HALF
U+00BE	¾	c2 be	VULGAR FRACTION THREE QUARTERS
U+00BF	¿	c2 bf	INVERTED QUESTION MARK
U+00C0	À	c3 80	LATIN CAPITAL LETTER A WITH GRAVE
U+00C1	Á	c3 81	LATIN CAPITAL LETTER A WITH ACUTE
U+00C2	Â	c3 82	LATIN CAPITAL LETTER A WITH CIRCUMFLEX
U+00C3	Ã	c3 83	LATIN CAPITAL LETTER A WITH TILDE
U+00C4	Ä	c3 84	LATIN CAPITAL LETTER A WITH DIAERESIS
U+00C5	Å	c3 85	LATIN CAPITAL LETTER A WITH RING ABOVE
U+00C6	Æ	c3 86	LATIN CAPITAL LETTER AE
U+00C7	Ç	c3 87	LATIN CAPITAL LETTER C WITH CEDILLA
U+00C8	È	c3 88	LATIN CAPITAL LETTER E WITH GRAVE
U+00C9	É	c3 89	LATIN CAPITAL LETTER E WITH ACUTE
U+00CA	Ê	c3 8a	LATIN CAPITAL LETTER E WITH CIRCUMFLEX
U+00CB	Ë	c3 8b	LATIN CAPITAL LETTER E WITH DIAERESIS
U+00CC	Ì	c3 8c	LATIN CAPITAL LETTER I WITH GRAVE
U+00CD	Í	c3 8d	LATIN CAPITAL LETTER I WITH ACUTE
U+00CE	Î	c3 8e	LATIN CAPITAL LETTER I WITH CIRCUMFLEX
U+00CF	Ï	c3 8f	LATIN CAPITAL LETTER I WITH DIAERESIS
U+00D0	Ð	c3 90	LATIN CAPITAL LETTER ETH
U+00D1	Ñ	c3 91	LATIN CAPITAL LETTER N WITH TILDE
U+00D2	Ò	c3 92	LATIN CAPITAL LETTER O WITH GRAVE
U+00D3	Ó	c3 93	LATIN CAPITAL LETTER O WITH ACUTE
U+00D4	Ô	c3 94	LATIN CAPITAL LETTER O WITH CIRCUMFLEX
U+00D5	Õ	c3 95	LATIN CAPITAL LETTER O WITH TILDE
U+00D6	Ö	c3 96	LATIN CAPITAL LETTER O WITH DIAERESIS
U+00D7	×	c3 97	MULTIPLICATION SIGN
U+00D8	Ø	c3 98	LATIN CAPITAL LETTER O WITH STROKE
U+00D9	Ù	c3 99	LATIN CAPITAL LETTER U WITH GRAVE
U+00DA	Ú	c3 9a	LATIN CAPITAL LETTER U WITH ACUTE
U+00DB	Û	c3 9b	LATIN CAPITAL LETTER U WITH CIRCUMFLEX
U+00DC	Ü	c3 9c	LATIN CAPITAL LETTER U WITH DIAERESIS
U+00DD	Ý	c3 9d	LATIN CAPITAL LETTER Y WITH ACUTE

Continued on page 20

Continued from page 19

Unicode Code Point	Character	UTF-8 (hex.)	Name
U+00DE	þ	c3 9e	LATIN CAPITAL LETTER THORN
U+00DF	ß	c3 9f	LATIN SMALL LETTER SHARP S
U+00E0	à	c3 a0	LATIN SMALL LETTER A WITH GRAVE
U+00E1	á	c3 a1	LATIN SMALL LETTER A WITH ACUTE
U+00E2	â	c3 a2	LATIN SMALL LETTER A WITH CIRCUMFLEX
U+00E3	ã	c3 a3	LATIN SMALL LETTER A WITH TILDE
U+00E4	ä	c3 a4	LATIN SMALL LETTER A WITH DIAERESIS
U+00E5	å	c3 a5	LATIN SMALL LETTER A WITH RING ABOVE
U+00E6	æ	c3 a6	LATIN SMALL LETTER AE
U+00E7	ç	c3 a7	LATIN SMALL LETTER C WITH CEDILLA
U+00E8	è	c3 a8	LATIN SMALL LETTER E WITH GRAVE
U+00E9	é	c3 a9	LATIN SMALL LETTER E WITH ACUTE
U+00EA	ê	c3 aa	LATIN SMALL LETTER E WITH CIRCUMFLEX
U+00EB	ë	c3 ab	LATIN SMALL LETTER E WITH DIAERESIS
U+00EC	ì	c3 ac	LATIN SMALL LETTER I WITH GRAVE
U+00ED	í	c3 ad	LATIN SMALL LETTER I WITH ACUTE
U+00EE	î	c3 ae	LATIN SMALL LETTER I WITH CIRCUMFLEX
U+00EF	ï	c3 af	LATIN SMALL LETTER I WITH DIAERESIS
U+00F0	ð	c3 b0	LATIN SMALL LETTER ETH
U+00F1	ñ	c3 b1	LATIN SMALL LETTER N WITH TILDE
U+00F2	ò	c3 b2	LATIN SMALL LETTER O WITH GRAVE
U+00F3	ó	c3 b3	LATIN SMALL LETTER O WITH ACUTE
U+00F4	ô	c3 b4	LATIN SMALL LETTER O WITH CIRCUMFLEX
U+00F5	õ	c3 b5	LATIN SMALL LETTER O WITH TILDE
U+00F6	ö	c3 b6	LATIN SMALL LETTER O WITH DIAERESIS
U+00F7	÷	c3 b7	DIVISION SIGN
U+00F8	ø	c3 b8	LATIN SMALL LETTER O WITH STROKE
U+00F9	ù	c3 b9	LATIN SMALL LETTER U WITH GRAVE
U+00FA	ú	c3 ba	LATIN SMALL LETTER U WITH ACUTE
U+00FB	û	c3 bb	LATIN SMALL LETTER U WITH CIRCUMFLEX
U+00FC	ü	c3 bc	LATIN SMALL LETTER U WITH DIAERESIS
U+00FD	ý	c3 bd	LATIN SMALL LETTER Y WITH ACUTE
U+00FE	þ	c3 be	LATIN SMALL LETTER THORN
U+00FF	ÿ	c3 bf	LATIN SMALL LETTER Y WITH DIAERESIS

## Clean with Mild Detergent and Water

Wipe down the enclosure and the display with a soft cloth that has been dampened with a mild detergent and warm water solution.

## Repairs

Contact Banner Engineering for troubleshooting of this device. **Do not attempt any repairs to this Banner device; it contains no field-replaceable parts or components.** If the device, device part, or device component is determined to be defective by a Banner Applications Engineer, they will advise you of Banner's RMA (Return Merchandise Authorization) procedure.

**IMPORTANT:** If instructed to return the device, pack it with care. Damage that occurs in return shipping is not covered by warranty.

## Contact Us

Banner Engineering Corp. headquarters is located at: 9714 Tenth Avenue North | Plymouth, MN 55441, USA | Phone: + 1 888 373 6767

For worldwide locations and local representatives, visit [www.bannerengineering.com](http://www.bannerengineering.com).

## Banner Engineering Corp Limited Warranty

Banner Engineering Corp. warrants its products to be free from defects in material and workmanship for one year following the date of shipment. Banner Engineering Corp. will repair or replace, free of charge, any product of its manufacture which, at the time it is returned to the factory, is found to have been defective during the warranty period. This warranty does not cover damage or liability for misuse, abuse, or the improper application or installation of the Banner product.

**THIS LIMITED WARRANTY IS EXCLUSIVE AND IN LIEU OF ALL OTHER WARRANTIES WHETHER EXPRESS OR IMPLIED (INCLUDING, WITHOUT LIMITATION, ANY WARRANTY OF MERCHANTABILITY OR FITNESS FOR A PARTICULAR PURPOSE), AND WHETHER ARISING UNDER COURSE OF PERFORMANCE, COURSE OF DEALING OR TRADE USAGE.**

This Warranty is exclusive and limited to repair or, at the discretion of Banner Engineering Corp., replacement. **IN NO EVENT SHALL BANNER ENGINEERING CORP. BE LIABLE TO BUYER OR ANY OTHER PERSON OR ENTITY FOR ANY EXTRA COSTS, EXPENSES, LOSSES, LOSS OF PROFITS, OR ANY INCIDENTAL, CONSEQUENTIAL OR SPECIAL DAMAGES RESULTING FROM ANY PRODUCT DEFECT OR FROM THE USE OR INABILITY TO USE THE PRODUCT, WHETHER ARISING IN CONTRACT OR WARRANTY, STATUTE, TORT, STRICT LIABILITY, NEGLIGENCE, OR OTHERWISE.**

Banner Engineering Corp. reserves the right to change, modify or improve the design of the product without assuming any obligations or liabilities relating to any product previously manufactured by Banner Engineering Corp. Any misuse, abuse, or improper application or installation of this product or use of the product for personal protection applications when the product is identified as not intended for such purposes will void the product warranty. Any modifications to this product without prior express approval by Banner Engineering Corp will void the product warranties. All specifications published in this document are subject to change; Banner reserves the right to modify product specifications or update documentation at any time. Specifications and product information in English supersede that which is provided in any other language. For the most recent version of any documentation, refer to: [www.bannerengineering.com](http://www.bannerengineering.com).

For patent information, see [www.bannerengineering.com/patents](http://www.bannerengineering.com/patents).

 [LinkedIn](#)

 [X \(formerly Twitter\)](#)

 [Facebook](#)

