

Features

2 Pole, forcibly guided contacts, relay interface modules, 15.8 mm wide

48.12 - 2 Pole 8 A (screw terminal)

- DC sensitive coils
- Relay with forcibly guided contacts according to EN 50205 Type B
- 35 mm rail (EN 60715) mounting

48.12
Screw terminal



According to EN 50205 only 1 NO and 1 NC (11-14 and 21-24 or 11-12 and 21-24) shall be used as forcibly guided contacts.

For outline drawing see page 7

48.12



- 2 pole, 8 A
- Forcibly guided contacts relay
- Screw terminal
- 35 mm rail (EN 60715) mounting

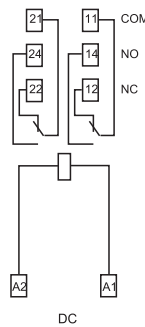

Contact specification		
Contact configuration		2 CO (DPDT)
Rated current/Maximum peak current	A	8/15
Rated voltage/Maximum switching voltage	V AC	250/400
Rated load AC1	VA	2,000
Rated load AC15 (230 V AC)	VA	500
Single phase motor rating (230 V AC)	kW	0.37
Breaking capacity DC1: 30/110/220V	A	8/0.65/0.2
Minimum switching load	mW (V/mA)	500 (10/10)
Standard contact material		AgNi
Coil specification		
Nominal voltage (U _N)	V AC (50/60 Hz)	—
	V DC	12 - 24
Rated power AC/sens. DC	VA (50 Hz)/W	—/0.7
Operating range	AC	—
	sens. DC	(0.75...1.2)U _N
Holding voltage	AC/DC	— /0.4 U _N
Must drop-out voltage	AC/DC	— /0.1 U _N
Technical data		
Mechanical life AC/DC	cycles	—/10 · 10 ⁶
Electrical life at rated load AC1	cycles	100 · 10 ³
Operate/release time	ms	10/4
Insulation between coil and contacts (1.2/50 μs)	kV	6 (8 mm)
Dielectric strength between open contacts	V AC	1,500
Ambient temperature range	°C	-40...+70
Protection category		IP 20
Approvals relay (according to type)		

Features

1 & 2 Pole relay interface modules,
15.8 mm wide

Ideal interface for PLC and electronic systems

- 48.31 - 1 Pole 10 A (screw terminal)
- 48.52 - 2 Pole 8 A (screw terminal)
- 48.72 - 2 Pole 8 A (screwless terminal)

- AC coils or DC sensitive coils
- Instant ejection of relay using plastic retaining clip
- Supply status indication and EMC coil suppression module as standard
- Identification label
- UL Listing (certain relay/socket combinations)
- 35 mm rail (EN 60715) mounting

48.31 / 48.52
Screw terminal



48.72
Screwless terminal



48.31



- 1 pole, 10 A
- Screw terminal
- 35 mm rail (EN 60715) mounting

48.52/72

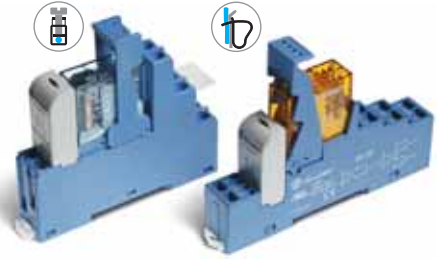

- 2 pole, 8 A
- Screw terminal and screwless terminal
- 35 mm rail (EN 60715) mounting

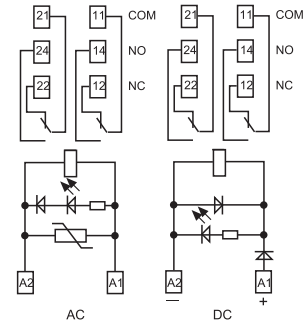
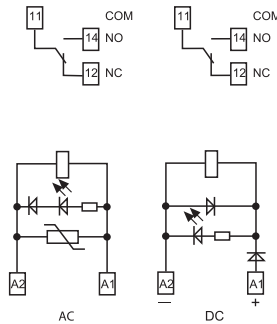

For outline drawing see page 7

Contact specification

Contact configuration		1 CO (SPDT)	2 CO (DPDT)
Rated current/Maximum peak current	A	10/20	8/15
Rated voltage/Maximum switching voltage	V AC	250/400	250/250
Rated load AC1	VA	2,500	2,000
Rated load AC15 (230 V AC)	VA	500	400
Single phase motor rating (230 V AC)	kW	0.37	0.3
Breaking capacity DC1: 30/110/220V	A	10/0.3/0.12	8/0.3/0.12
Minimum switching load	mW (V/mA)	300 (5/5)	300 (5/5)
Standard contact material		AgNi	AgNi

Coil specification

Nominal voltage (U_N)	V AC (50/60 Hz)	12 - 24 - 110 - 120 - 230	12 - 24 - 110 - 120 - 230
	V DC	12 - 24 - 125	12 - 24 - 125
Rated power AC/sens. DC	VA (50 Hz)/W	1.2/0.5	1.2/0.5
Operating range	AC	$(0.8...1.1)U_N$	$(0.8...1.1)U_N$
	sens. DC	$(0.73...1.75)U_N$	$(0.73...1.75)U_N$
Holding voltage	AC/DC	$0.8 U_N / 0.4 U_N$	$0.8 U_N / 0.4 U_N$
Must drop-out voltage	AC/DC	$0.2 U_N / 0.1 U_N$	$0.2 U_N / 0.1 U_N$

Technical data

Mechanical life AC/DC	cycles	$10 \cdot 10^6 / 20 \cdot 10^6$	$10 \cdot 10^6 / 20 \cdot 10^6$
Electrical life at rated load AC1	cycles	$200 \cdot 10^3$	$100 \cdot 10^3$
Operate/release time	ms	7/4 (AC) - 12/12 (DC)	7/4 (AC) - 12/12 (DC)
Insulation between coil and contacts (1.2/50 μ s)	kV	6 (8 mm)	6 (8 mm)
Dielectric strength between open contacts	V AC	1,000	1,000
Ambient temperature range	$^{\circ}$ C	-40...+70	-40...+70
Protection category		IP 20	IP 20

Approvals relay (according to type)



Features

1 & 2 Pole relay interface modules,
15.8 mm wide

Ideal interface for PLC and electronic systems

- 48.61 - 1 Pole 16 A (screw terminal)
- 48.81 - 1 Pole 16 A (screwless terminal)
- 48.62 - 2 Pole 10 A (screw terminal)
- 48.82 - 2 Pole 10 A (screwless terminal)

- AC coils or DC sensitive coils
- Instant ejection of relay using plastic retaining clip
- Supply status indication and EMC coil suppression module as standard
- Identification label
- UL Listing (certain relay/socket combinations)
- 35 mm rail (EN 60715) mounting

48.61 / 48.62
Screw terminal



48.81 / 48.82
Screwless terminal



For outline drawing see page 7

Contact specification

Contact configuration	1 CO (SPDT)	2 CO (DPDT)
Rated current/Maximum peak current	A 16*/30	10/20
Rated voltage/Maximum switching voltage V AC	250/400	250/400
Rated load AC1	VA 4,000	2,500
Rated load AC15 (230 V AC)	VA 750	500
Single phase motor rating (230 V AC)	kW 0.55	0.37
Breaking capacity DC1: 30/110/220V	A 16/0.3/0.12	10/0.3/0.12
Minimum switching load	mW (V/mA) 500 (10/5)	300 (5/5)
Standard contact material	AgCdO	AgNi

Coil specification

Nominal voltage (U _N)	V AC (50/60 Hz)	12 - 24 - 110 - 120 - 230	—
	V DC	12 - 24 - 125	12 - 24 - 125
Rated power AC/sens. DC	VA (50 Hz)/W	1.2/0.5	—/0.5
Operating range	AC	(0.8...1.1)U _N	—
	sens. DC	(0.8...1.5)U _N	(0.8...1.5)U _N
Holding voltage	AC/DC	0.8 U _N / 0.4 U _N	—/0.4 U _N
Must drop-out voltage	AC/DC	0.2 U _N / 0.1 U _N	—/0.1 U _N

Technical data

Mechanical life AC/DC	cycles	10 · 10 ⁶ /20 · 10 ⁶	—/20 · 10 ⁶
Electrical life at rated load AC1	cycles	100 · 10 ³	100 · 10 ³
Operate/release time	ms	7/4 (AC) - 12/12 (DC)	12/12 (DC)
Insulation between coil and contacts (1.2/50 μs)	kV	6 (8 mm)	6 (8 mm)
Dielectric strength between open contacts	V AC	1,000	1,000
Ambient temperature range	°C	−40...+70	−40...+70
Protection category		IP 20	IP 20

Approvals relay (according to type)

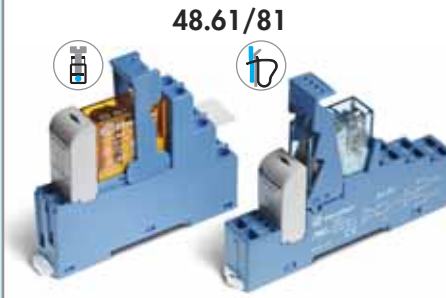

48.61/81

- 1 pole, 16 A
- Screw terminal and screwless terminal
- 35 mm rail (EN 60715) mounting

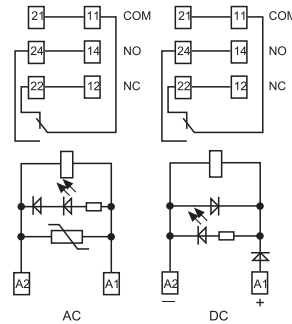

* For currents >10 A, contact terminals must be connected in parallel (21 with 11, 24 with 14, 22 with 12).

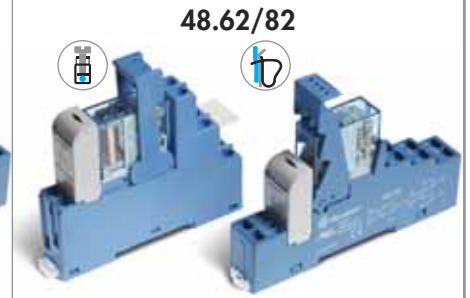

48.62/82

- 2 pole, 10 A
- Screw terminal and screwless terminal
- 35 mm rail (EN 60715) mounting

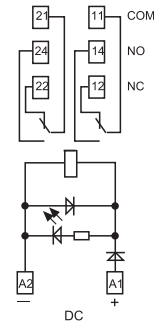

Ordering information

Example: 48 series, 35 mm rail (EN 60715) mount, screw terminal relay interface module, 2 CO (DPDT) 8 A contacts, 24 V sensitive DC coil, green LED + diode, 99.02 coil indication.

4 8 . 5 2 . 7 . 0 2 4 . 0 0 5 0

Series _____

Type _____
Screw terminal
1 = 35 mm rail (EN 60715) mount, forcibly guided contacts relay
3 = 35 mm rail (EN 60715) mount
5 = 35 mm rail (EN 60715) mount
6 = 35 mm rail (EN 60715) mount
Screwless terminal
7 = 35 mm rail (EN 60715) mount
8 = 35 mm rail (EN 60715) mount

No. of poles _____
1 = 1 pole for 48.31, 10 A
48.61, 48.81, 16 A
2 = 2 pole for 48.12, 48.52, 48.72, 8 A
48.62, 48.82, 10 A
(48.62, 48.82 DC only)

Coil version _____
7 = Sensitive DC
8 = AC (50/60 Hz)
9 = DC

Coil voltage _____
See coil specifications

A: Contact material
0 = Standard AgNi for 48.31/52/62/72/82 AgCdO, Standard for 48.61/81
1 = AgNi, for 48.12
4 = AgSnO₂, for 48.61/62/81/82 only
5 = AgNi + Au (5 μm), for 48.31/52/72 only

B: Contact circuit
0 = CO (nPDT)

D: Special versions
0 = Standard
2 = Standard (for 48.12 only)

C: Options
0 = Standard (for 48.12 only)
5 = Standard for DC:
green LED + diode (polarity +A1)
6 = Standard for AC:
green LED + Varistor

Selecting features and options: only combinations in the same row are possible.
Preferred selections for best availability are shown in **bold**.

Type	Coil version	A	B	C	D
48.12	DC	1	0	0	2
48.31/52/72	AC	0 - 5	0	6	0
48.31/52/72	Sensitive DC	0 - 5	0	5	0
48.61/81	AC	0 - 4	0	6	0
48.61/81	Sensitive DC	0 - 4	0	5	0
48.62/82	Sensitive DC	0 - 4	0	5	0

Technical data

Insulation		48.12/31/61/62	48.52/72	48.12/31/61/62/81/82	
Insulation according to EN 61810-1	insulation rated voltage	V 250	250	400	
	rated impulse withstand voltage	kV 4	4	4	
	pollution degree	3	2	2	
	overvoltage category	III	III	III	
Insulation between coil and contacts (1.2/50 μs)		kV 6 (8 mm)			
Dielectric strength between open contacts		V AC 1,000; 1,500 (48.12)			
Dielectric strength between adjacent contacts		V AC 2,000 (48.52); 2,500 (48.12/62)			
Conducted disturbance immunity					
Burst (5...50)ns, 5 kHz, on A1 - A2		EN 61000-4-4		level 4 (4 kV)	
Surge (1.2/50 μs) on A1 - A2 (differential mode)		EN 61000-4-5		level 3 (2 kV)	
Other data					
Bounce time: NO/NC		ms 2/5; 2/10 (48.12)			
Vibration resistance (5...55)Hz: NO/NC		g 10/4 (for 1 pole)		15/3; 20/6 (48.12) for 2 pole	
Power lost to the environment	without contact current	W 0.7			
	with rated current	W 1.2 (48.12/31)	1.3 (48.52/72)	1.2 (48.61/62/81/82)	
Wire strip length		mm 8			
Screw torque		Nm 0.5			
Max. wire size		Screw terminal		Screwless terminal	
		solid cable	stranded cable	solid cable	stranded cable
	mm ²	1x6 / 2x2.5	1x4 / 2x2.5	2x(0.2...1.5)	2x(0.2...1.5)
	AWG	1x10 / 2x14	1x12 / 2x14	2x(24...18)	2x(24...18)

Contact specification

F 48 - Electrical life (AC) v contact current
Types 48.31/61/81

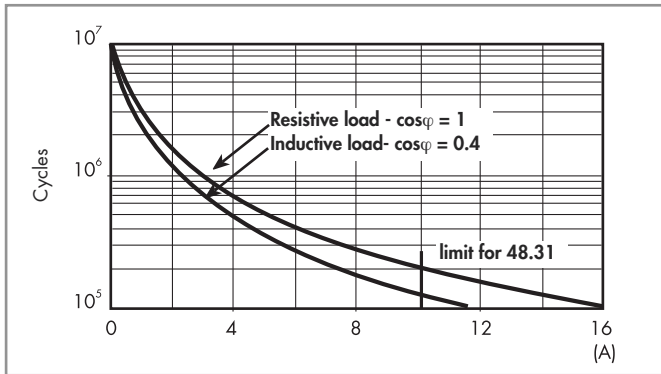

F 48 - Electrical life (AC) v contact current
Types 48.62/82

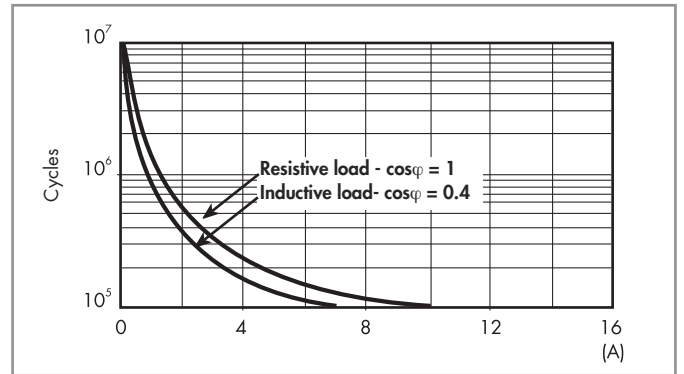

F 48 - Electrical life (AC) v contact current
Types 48.52/72

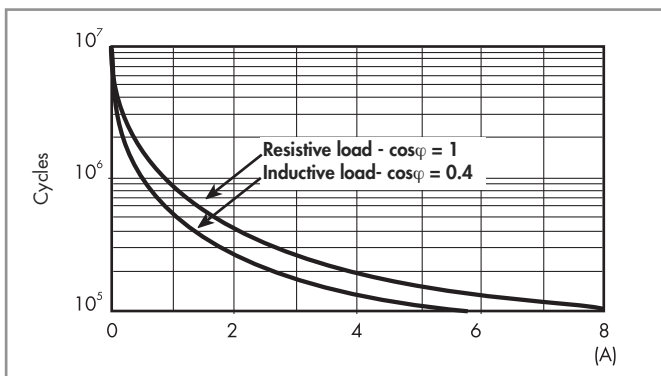

F 48 - Electrical life (AC) v contact current
Type 48.12

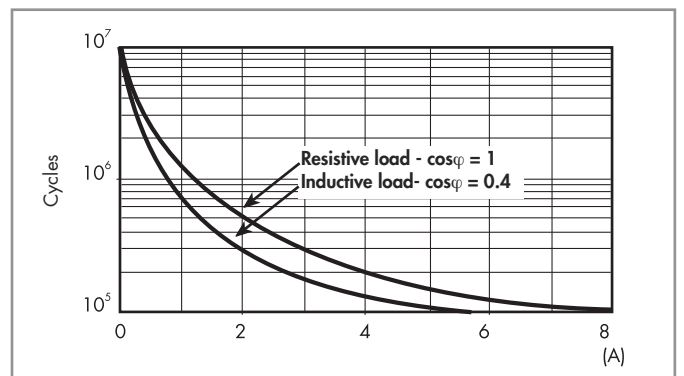

H 48 - Maximum DC1 breaking capacity
Types 48.31/52/61/72/81

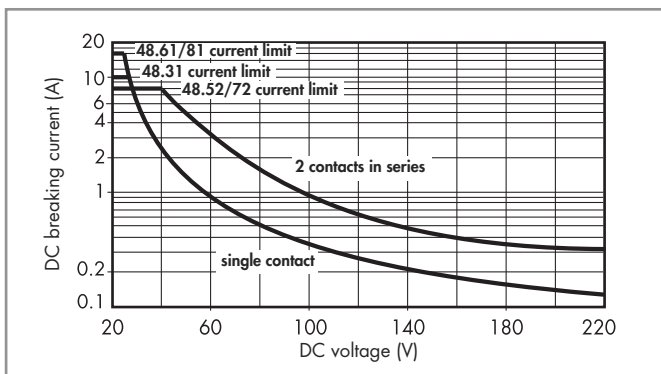

H 48 - Maximum DC1 breaking capacity
Types 48.62/82

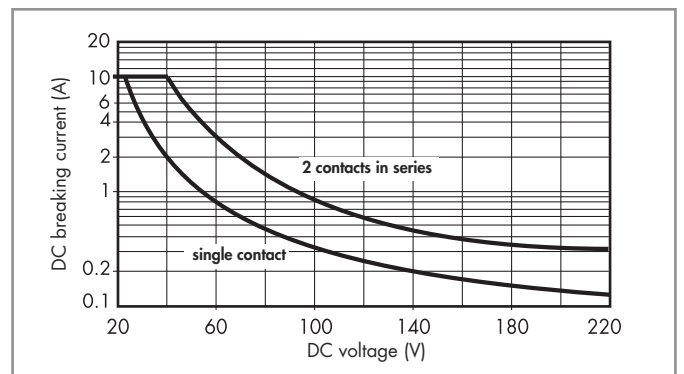

H 48 - Maximum DC1 breaking capacity
Type 48.12

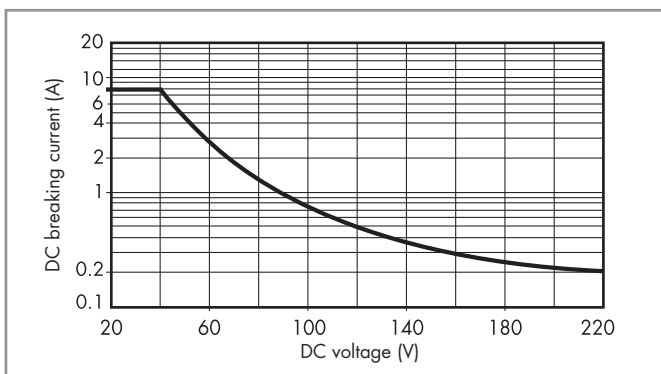

- When switching a resistive load (DC1) having voltage and current values under the curve, an electrical life of $\geq 100 \cdot 10^3$ can be expected.
- In the case of DC13 loads, the connection of a diode in parallel with the load will permit a similar electrical life as for a DC1 load.
Note: the release time for the load will be increased.

Coil specifications

DC coil data (0.5 W sensitive)

Nominal voltage U_N V	Coil code	Operating range		Rated coil consumption I at U_N mA
		U_{min}^* V	U_{max}^{**} V	
12	7.012	8.8	21	41
24	7.024	17.5	42	22.2
125	7.125	91	219	4

* $U_{min} = 0.8 U_N$ for 48.61, 48.62, 48.81 and 48.82

** $U_{max} = 1.5 U_N$ for 48.61, 48.62, 48.81 and 48.82

AC coil data

Nominal voltage U_N V	Coil code	Operating range		Rated coil consumption I at U_N (50Hz) mA
		U_{min} V	U_{max} V	
12	8.012	9.6	13.2	90.5
24	8.024	19.2	26.4	46
110	8.110	88	121	10.1
120	8.120	96	132	11.8
230	8.230	184	253	7.0

DC coil data, 2 pole relay - Type 48.12

Nominal voltage U_N V	Coil code	Operating range		Resistance R Ω	Rated coil consumption I at U_N mA
		U_{min} V	U_{max} V		
12	9.012	9	14.4	205	58.5
24	9.024	18	28.8	820	29.3

R 48 - DC coil operating range v ambient temperature

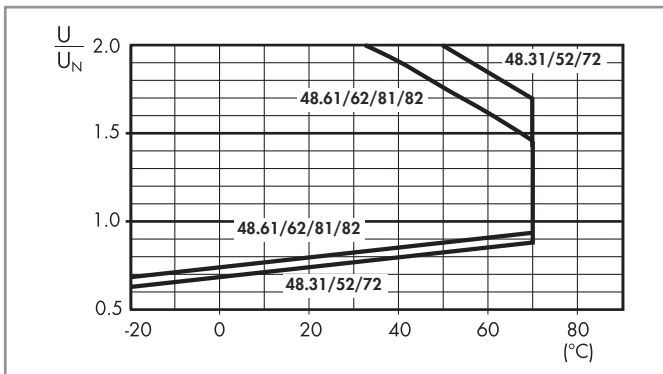

- 1 - Max. permitted coil voltage.
- 2 - Min. pick-up voltage with coil at ambient temperature.

R 48 - AC coil operating range v ambient temperature

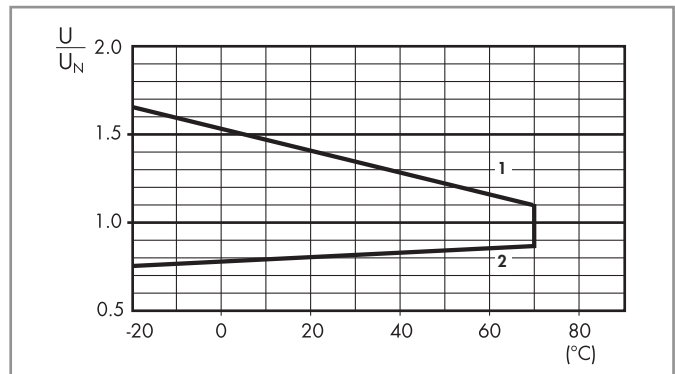

- 1 - Max. permitted coil voltage.
- 2 - Min. pick-up voltage with coil at ambient temperature.

R 48 - DC coil operating range v ambient temperature Type 48.12

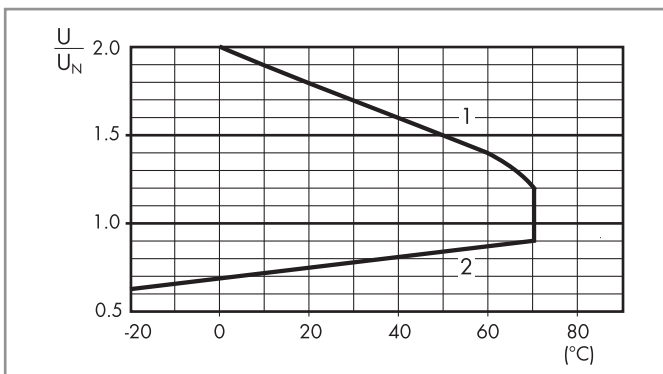

- 1 - Max. permitted coil voltage.
- 2 - Min. pick-up voltage with coil at ambient temperature.

Combinations

Code	Type of socket	Type of relay	Module	Retaining clip
48.12	95.05.0	50.12	—	095.71
48.31	95.03	40.31	99.02	095.01
48.52	95.05	40.52	99.02	095.01
48.61	95.05	40.61	99.02	095.01
48.62	95.05	44.62	99.02	095.01
48.72	95.55	40.52	99.02	095.91.3
48.81	95.55	40.61	99.02	095.91.3
48.82	95.55	44.62	99.02	095.91.3

Outline drawing

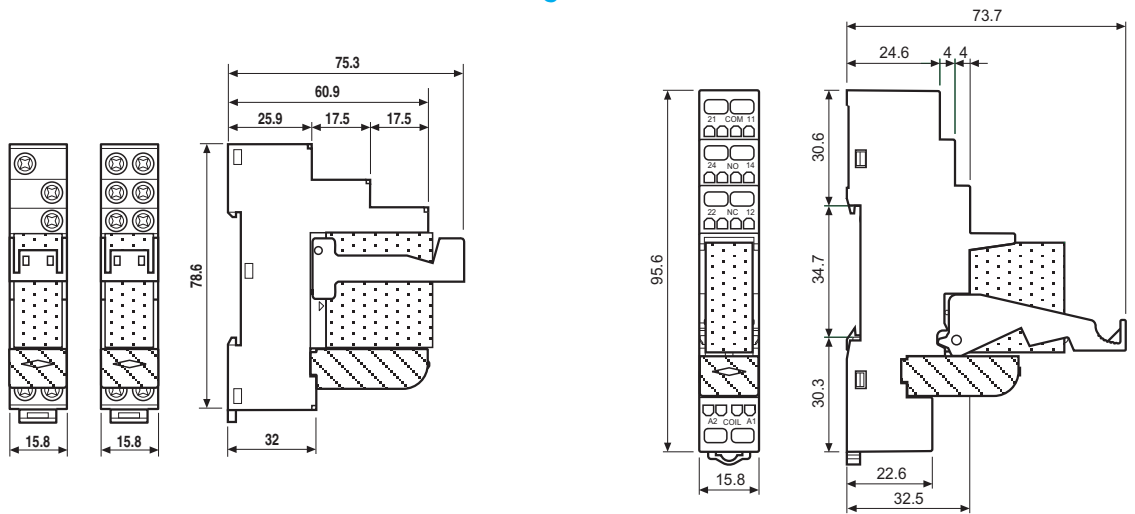

48.31 48.52 / 48.61 / 48.62
Screw terminal



48.72 / 48.81 / 48.82
Screwless terminal

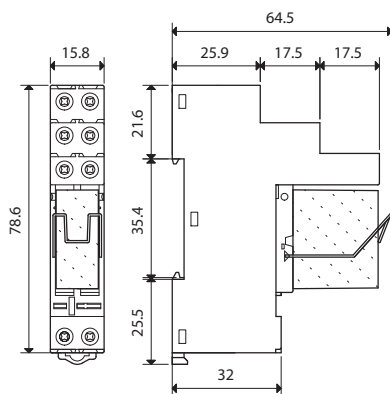

48.12
Screw terminal



Accessories



095.18



8-way jumper link for screw terminal version	095.18 (blue)	095.18.0 (black)
Rated values	10 A - 250 V	

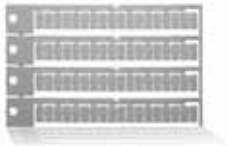
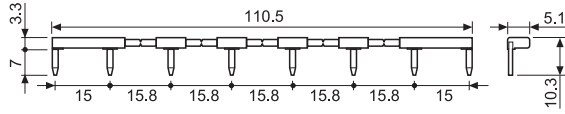

060.72

Sheet of marker tags , plastic, 72 tags, 6x12 mm	060.72
---	--------

Packaging codes

How to code and identify retaining clip and packaging options for sockets.

Example:

4 8 . 5 2 . 7 . 0 2 4 . 0 0 5 0 S P A

