

EB3L Discrete Output Barriers

126 types of pilot lights and buzzers can be connected. Illuminated pushbuttons and illuminated selector switches can be connected by combining with the EB3C discrete input barrier. No grounding required.

Key features:

Ratings	
Discrete Output Barrier	[Exia II C
Pilot Light (separate wiring)	Exia II CT6
Pilot Light (common wiring)	Exia II CT4
Illuminated Pushbutton	Exia II CT4
Illuminated Selector Switch	Exia II CT4
Buzzer (separate wiring)	Exiab II CT6

- IEC60079 compliant
- Compact and lightweight
- 8- and 16-channel types are available in common wiring types, ideal for connection to PLCs. 16-circuit types are also available with a connector.
- Universal AC power voltage (100 to 240V AC or 24V DC power [UL rating: 100 ~ 120V AC])
- No grounding required
- IDEC's original spring-up terminal minimizes wiring time.
- Installation, 35-mm-wide DIN rail mounting or direct screw mounting
- ø6, ø8, ø10, ø22 and ø30 pilot lights available
- Illuminated pushbuttons and illuminated selector switches can be connected by combining with the EB3C discrete input barrier. Illumination colors: Amber, blue, green, red, white, and yellow (pushlock turn reset type: red only)
- Continuous and intermittent sound types are available for buzzers (ø30).
- Global usage
 USA: UL/FM
 Europe: CE marking
 Global: IECEx, ATEX
 Japan: TIIS
 China: CQST
 Korea: KCs
- Ship class: NK (Japan), KR (Korea)



Illuminated Pushbutton/Selector Switches

Illuminated pushbutton/selector switches can be used with the combination of EB3C and EB3L.



Spring-up Fingersafe Terminals Reduce Wiring Time

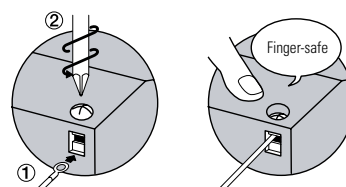

Entity Barrier Parameters

Ta= 60°C, Um= 250V, (Um=125V UL only), Uo=13.2V, Io= 14.2mA, Po= 46.9mW at each channel
 Pn-Nn Io=227.2mA, Po= 750mW at max 16 channels Pn-Nn

Io(mA)	14.2	28.4	42.6	56.8	71.0	85.2	99.4	113.6	127.8	142.0	156.2	170.4	184.6	198.8	213.0	227.2	Combined Lo(mH)
Po(mW)	46.9	93.8	140.6	187.5	234.3	281.2	328.1	375.9	421.8	468.7	515.5	562.4	609.2	656.1	702.9	750	
Co(μF)	0.67	0.65	0.63	0.61	0.59	0.57	0.55	0.53	0.51	0.49	0.47	0.44	0.42	0.39	-	-	1.0
	0.79	0.77	0.76	0.75	0.73	0.72	0.70	0.69	0.67	0.66	0.64	0.62	0.61	0.59	0.57	0.55	0.5
	0.94	0.94	0.94	0.94	0.94	0.94	0.94	0.93	0.92	0.91	0.90	0.88	0.87	0.86	0.85	0.84	0.2
	0.94	0.94	0.94	0.94	0.94	0.94	0.94	0.94	0.94	0.94	0.94	0.94	0.94	0.94	0.94	0.94	0.1

Note 1 Added to above table, the next values combined Lo and Co are allowable;

Io(mA)	14.2					28.4					227.2							
Lo(mH)	175*	87.5	30.0	2.5	0.55	0.25	43.5*	21.5	20.0	3.5	0.43	0.25	0.68*	0.34	0.68	0.6	0.22	0.13
Co(μF)	0.90*	0.45	0.33	0.54	0.77	0.90	0.90*	0.45	0.30	0.48	0.80	0.90	0.90*	0.45	0.45	0.49	0.80	0.90

TIIS, NK only
 Ta=60°C, Um=250V

	1 ch	16 ch
	Seperate	Common 16
Uo	13.2V	13.2V
Io	14.2mA	227.2mA
Po	46.9mW	750mW
Co	0.47μF	0.365μF
Lo	87.5mH	0.425mH

Note 2 The intrinsic safe apparatus and wirings shall be accordance to following formulas; for example: $U_i \geq U_o$ $I_i \geq I_o$ $P_i \geq P_o$ $C_i + C_c \leq C_o$ $L_i + L_c \leq L_o$
 *: Therefore, the values are allowable only at $L_i \leq 1\%L_o$ and $C_i \leq 1\%C_o$ of the intrinsic safe apparatus. (In the case of 50% of C_o and L_o parameters are applicable, the maximum capacitance allowed shall not be more than $C_o = 1 \mu F$ for IIB and $C_o = 600 nF$ for IIC.)

Common Wiring for PLC Inputs

8- and 16-circuit types are available in common wiring types, ideal for connection to PLCs (DC voltage only).

Connector Type

- MIL connector on the non-hazardous side
- Easy connection to PLCs
 - Wiring is reduced by 90%
 - Various 20-pin MIL connectors can be connected.

Specifications

Electrical Specifications

Ratings	Intrinsic safety type (IEC compliant) [Exia] II C	
Degree of Protection	IP20 (IEC60529)	
Installation Location	Discrete Output Barrier	Safe indoor place (non-hazardous area)
	Pilot Light, Illuminated Switch,	For zone 0, 1, 2 hazardous areas
	Buzzer	For zone 1 and 2 hazardous areas
Non-intrinsically Safe Circuit Maximum Voltage (Um)	250V AC 50/60Hz, 250V DC UL value: 125V AC	
Operation	Input ON, Output ON (1:1)	

Certifications

Certification Organization	Ratings	Certification No.
UL	Class I, II, III Div. 1 Group A, B, C, D, E, F, and G Class I, Zone 0 [AExia] II C	E234997
FM	Class I, II, III Div. 1 Group A, B, C, D, E, F, and G Class I, Zone 0 [AExia] II C	3047250
PTB (IEC-Ex)	[Exia] IIC: Gas vapor	IECEX PTB 10.0015
PTB (ATEX)	II(1)G [Exia] IIC: Gas vapor II(1)D [Exia] IIIC: Dust	PTB09 ATEX2046
TIIS	Discrete output barrier: [Exia] II C	TC20541
	Pilot light/miniature pilot light: (separate wiring): Exia II CT6	TC16361
	Pilot light/miniature pilot light: (common wiring): Exia II CT4	TC16360
	Illuminated switch: Exia II CT4	TC16362
Buzzer: Exib II CT6	TC20797	
NK	Discrete output barrier: [Exia] II C Buzzer: Exib II CT6	Type Test No. 13T606 pending
CQST	[Exia Ga] IIC	CNEx 14.0047
KCs	Discrete output barrier: [Exia] II C Buzzer: Exib II CT6	KCS14-AV4B0-0375 pending
KR	[Exia] IIC	pending



Note: Illuminated switches, pilot lights, and miniature pilot lights are certified by TIIS and NK only. Other certification organizations, such as UL, regard these units as simple apparatus, and require no certification.

General Specifications

Power Voltage Type	AC Power	DC Power
Rated Power Voltage	100 to 240V AC (UL rating: 100 ~ 120V AC)	24V DC
Allowable Voltage Range	85 to 264V AC (UL rating: 85 ~ 125V AC)	21.6 to 26.4V DC
Rated Frequency	50/60 Hz (allowable range: 47 to 63 Hz)	—
Inrush Current	10A (100V AC) 20A (200V AC)	10A
Dielectric Strength (1 minute, 1 mA)	Between intrinsically safe circuit and non-intrinsically safe circuit: 1526.4V AC	
	Between AC power and signal input: 1500V AC	
Operating Temperature	-20 to +60°C (no freezing)	
Storage Temperature	-20 to +60°C (no freezing)	
Operating Humidity	45 to 85% RH (no condensation)	
Atmosphere	800 to 1100 hPa	
Pollution Degree	2 (IEC60664)	
Insulation Resistance	10 MΩ minimum (500V DC megger, between the same poles as the dielectric strength)	
Vibration Resistance (damage limits)	Panel mounting: 10 to 55 Hz, amplitude 0.75 mm (2 hours each on X, Y, Z)	
	DIN rail mounting: 10 to 55 Hz, amplitude 0.35 mm (2 hours each on X, Y, Z)	
Shock Resistance (damage limits)	Panel mounting: 500 m/s ² (3 times each on X, Y, Z)	
	DIN rail mounting: 300 m/s ² (3 times each on X, Y, Z)	
Terminal Style	M3 screw terminal	
Mounting	35-mm-wide DIN rail or panel mounting (M4 screw)	
Power Consumption (approx.)	8.8 VA (EB3L-S10SAN at 200V AC)	
	5.2 W (EB3L-S16CSDN at 24V DC)	

Part Numbers

Discrete Output Barriers

Power Voltage	Connection to Non-intrinsically Safe Circuit	Input	Input Wiring Method	Number of Channels	Part Number	Weight (g)	
100 to 240V AC (UL rating: 100 ~ 120V AC)	Screw Terminal	Source	Separate/Common Wiring Compatible	1	EB3L-S01SAN	150	
				2	EB3L-S02SAN	180	
				3	EB3L-S03SAN	190	
				5	EB3L-S05SAN	250	
				6	EB3L-S06SAN	260	
				8	EB3L-S08SAN	330	
				10	EB3L-S10SAN	360	
				8	EB3L-S08CSAN	260	
		Sink	Separate/Common Wiring Compatible	1	EB3L-S01KAN	150	
				2	EB3L-S02KAN	180	
				3	EB3L-S03KAN	190	
				5	EB3L-S05KAN	250	
				6	EB3L-S06KAN	260	
				8	EB3L-S08KAN	330	
				10	EB3L-S10KAN	360	
				8	EB3L-S08CKAN	260	
24V DC	Screw Terminal	Source	Separate/Common Wiring Compatible	1	EB3L-S01SDN	130	
				2	EB3L-S02SDN	160	
				3	EB3L-S03SDN	170	
				5	EB3L-S05SDN	240	
				6	EB3L-S06SDN	250	
				8	EB3L-S08SDN	310	
				10	EB3L-S10SDN	250	
				8	EB3L-S08CSDN	340	
		16	EB3L-S16CSDN	350			
		Sink	Separate/Common Wiring Compatible	1	EB3L-S01KDN	130	
				2	EB3L-S02KDN	160	
				3	EB3L-S03KDN	170	
				5	EB3L-S05KDN	240	
				6	EB3L-S06KDN	250	
				8	EB3L-S08KDN	310	
				10	EB3L-S10KDN	340	
	8			EB3L-S08CKDN	250		
	Connector	Source	Common Wiring Only	16	EB3L-S16CSD-CN	350	
				Sink	16	EB3L-S16CKD-CN	350

Accessories

Name	Part Number	Description
DIN Rail	BAA1000	Aluminum (1m long, 10.5mm high)
	BAP1000	Steel (1m long, 7.5mm high)
End Clip	BNL6	Medium DIN rail end clip

IO Touchscreens

PLCs

Automation Software

Power Supplies

Sensors

Communication

Barriers

Internal Circuit Block Diagram

Oil Touchscreens

PLCs

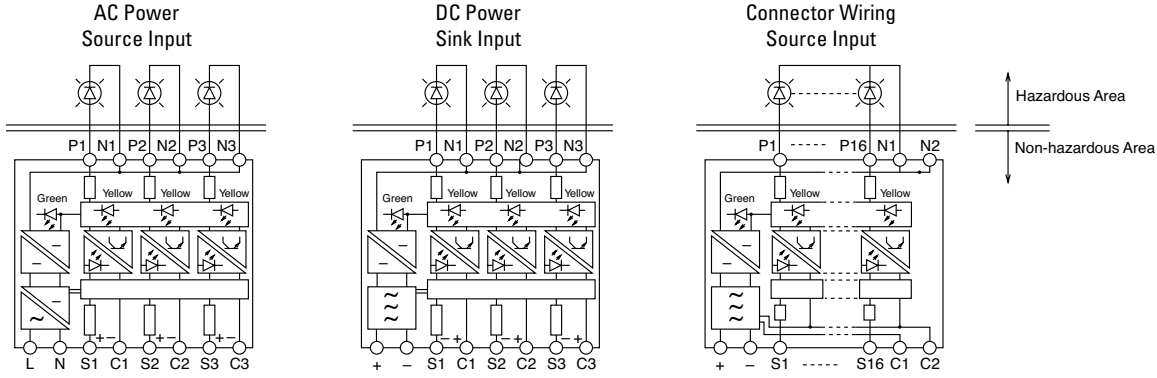

Dimensions (mm)

Terminal

Automation Software

Power Supplies

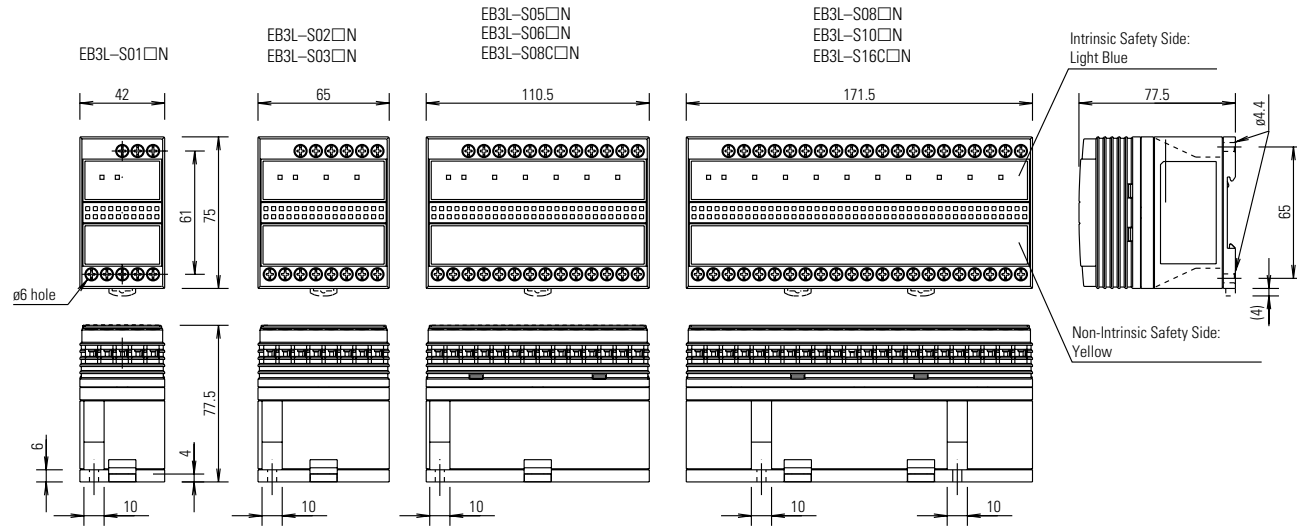

Mounting Hole Layout (Screw Mounting)

Sensors

Communication

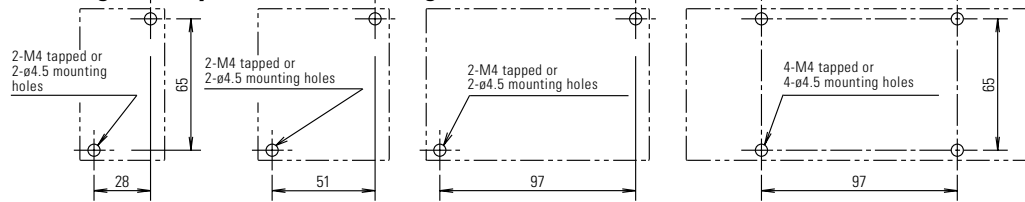

Connector

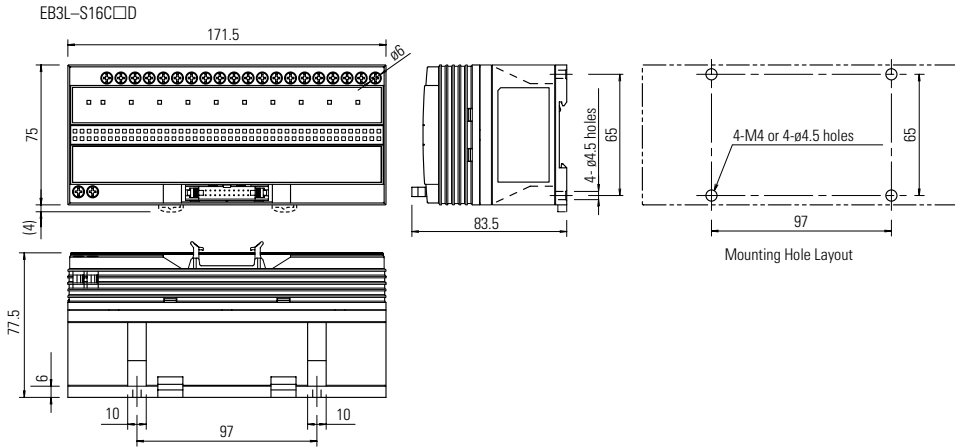

Applicable Crimping Terminal

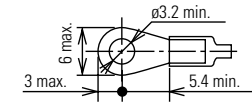

Solid Wire - Strip wire end

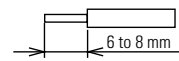

Stranded Wire - use a ferrule

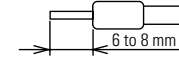

Non-intrinsically Safe External Input Wiring Examples

6-channel Source
(Ex.: EB3L-S06SAN)

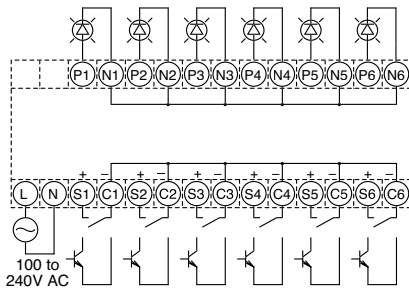

8-channel Common Wiring, Source
(Ex.: EB3L-S08CSDN)

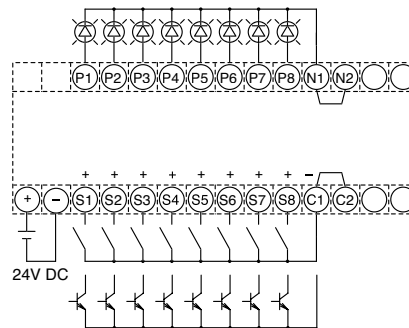

6-channel Sink
(Ex. EB3L-S06KAN)

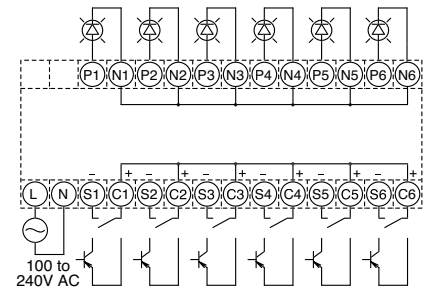

16-channel Common Wiring, Source
(Ex.: EB3L-S16CSDN)

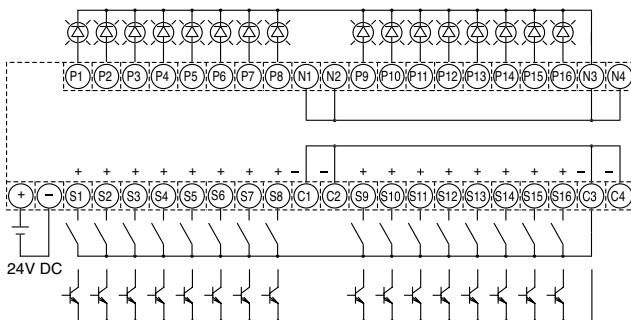

16-channel Common Wiring, Sink
(Ex.: EB3L-S16CKDN)

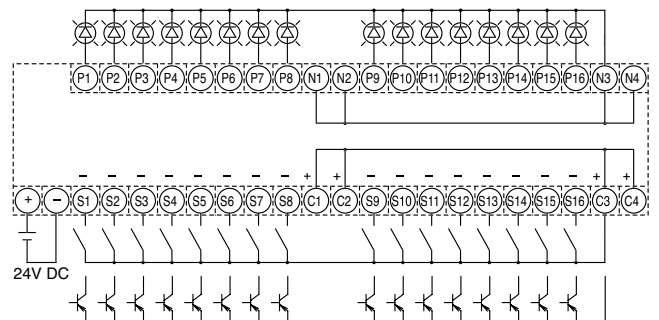

Note: Source input type can be connected to PLC sink output type C terminal is the negative common line.

Note: Sink input type can be connected to PLC source output type C terminal is the positive common line.

All dimensions are in mm

Connector Wiring Terminal Arrangement

EB3L-S16CSD-CN

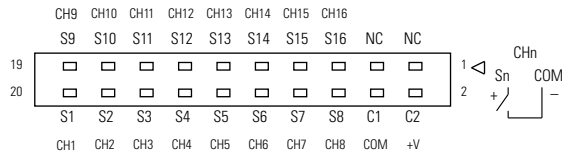

OI Touchscreens

PLCs

Automation Software

Power Supplies

Sensors

Communication

Barriers

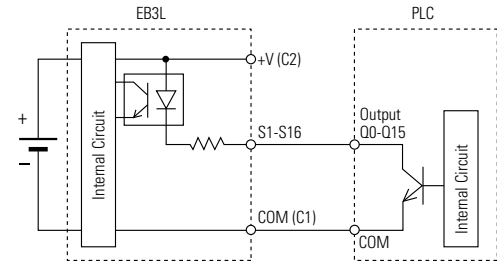

EB3L-S16CKD-CN

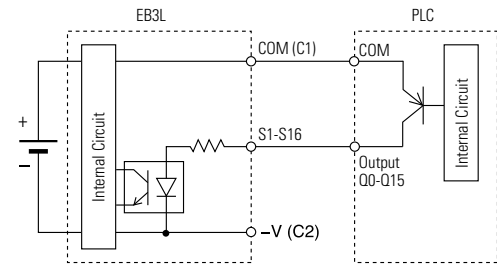
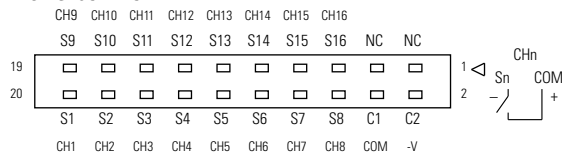

Wiring Example with IDEC's MicroSmart PLC Output Modules

FC4A-T16K3		EB3L-S16CSD-CN		FC4A-T16S3		EB3L-S16CKD-CN	
Terminal	Output	Input	Terminal	Terminal	Output	Input	Terminal
20	Q0	S1	20	20	Q0	S1	20
19	Q10	S9	19	19	Q10	S9	19
18	Q1	S2	18	18	Q1	S2	18
17	Q11	S10	17	17	Q11	S10	17
16	Q2	S3	16	16	Q2	S3	16
15	Q12	S11	15	15	Q12	S11	15
14	Q3	S4	14	14	Q3	S4	14
13	Q13	S12	13	13	Q13	S12	13
12	Q4	S5	12	12	Q4	S5	12
11	Q14	S13	11	11	Q14	S13	11
10	Q5	S6	10	10	Q5	S6	10
9	Q15	S14	9	9	Q15	S14	9
8	Q6	S7	8	8	Q6	S7	8
7	Q16	S15	7	7	Q16	S15	7
6	Q7	S8	6	6	Q7	S8	6
5	Q17	S16	5	5	Q17	S16	5
4	COM	COM	4	4	COM	COM	4
3	COM	NC	3	3	COM	NC	3
2	+V	+V	2	2	-V	-V	2
1	+V	NC	1	1	-V	NC	1



Note: The wiring in dashed line does not affect the operation of the EB3L. Applicable connector is IDEC's JE1S-201. Output power for PLC outputs is supplied by the EB3L, therefore the PLC output does not need an external power supply.

Wiring Example of Intrinsically Safe External Outputs

1. Common Wiring (Maximum 16 circuits) (Buzzers cannot be wired in a common line.)*

All output lines are wired to a common line inside the intrinsically safe equipment (one common line per intrinsically safe circuit) - DC input models only.

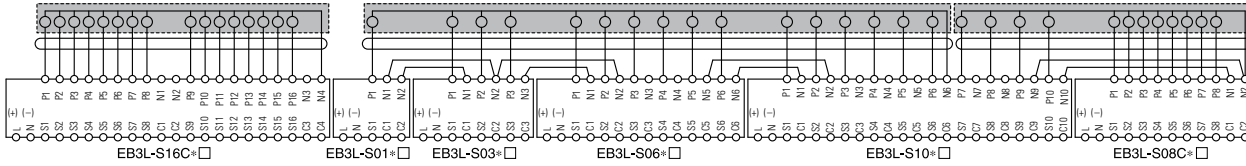

All input lines are wired to a common line outside the intrinsically safe equipment (one common line per intrinsically safe circuit).

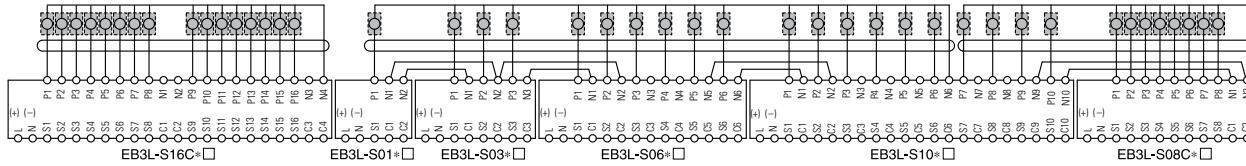

2. Separate Wiring

Each output line of the EB3L makes up one independent intrinsically safe circuit of a pilot light or buzzer.

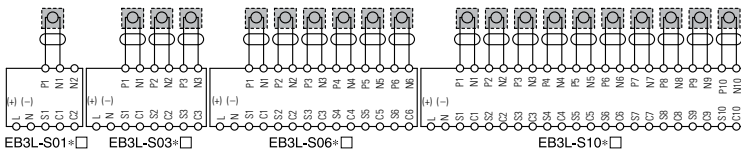

When using two or more EB3L's to set up one intrinsically safe circuit in the common wiring configuration, interconnect two neutral terminals (N1 through N10) on each EB3L between adjacent EB3L's in a parallel.

3. Wiring Illuminated Pushbuttons and Illuminated Selector Switches

(A maximum of 16 channels of EB3L and EB3C can be wired to a common line.)

The following example illustrates the wiring for a total of 10 contacts used by three illuminated pushbuttons (LB1 to LB3) and three illuminated selector switches (LS1 to LS3).

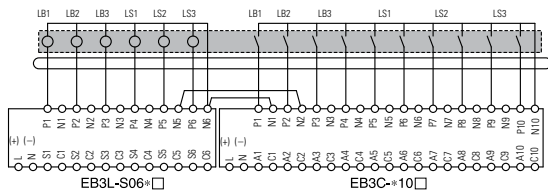
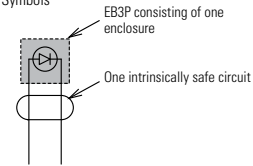



Diagram Symbols



 *This is permitted under TIIS approvals

Recommended Connector Cable for Connector Types

Description	No. of Poles	Length (m)	Part Number	Shape	Applicable Type	
I/O Terminal Cable	With Shield	0.5	FC9Z-H050A20		IDEC MicroSmart I/O Module	
		1	FC9Z-H100A20			
		2	FC9Z-H200A20			
	Without Shield	0.5	FC9Z-H050B20			
		1	FC9Z-H100B20			
		2	FC9Z-H200B20			
Cable with Crimping Terminal	20	1	BX9Z-H100E4		Screw Terminal	
		2	BX9Z-H200E4			
		3	BX9Z-H300E4			
40-pin Cable for PLC	20	1	BX9Z-H100B		Mitsubishi A Series Output Module (sink) ↓ EB3L-S16CSD-CN	
		2	BX9Z-H200B			
		3	BX9Z-H300B			

FC9Z-H□□□A, FC9Z-H□□□B Internal Connection

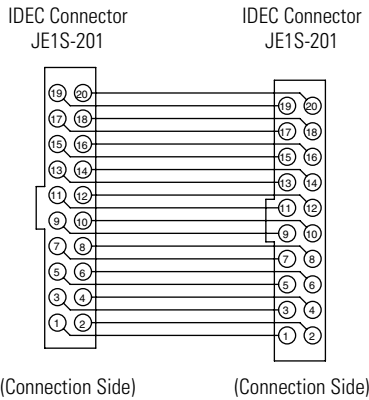

BX9Z-H□□□B Internal Connection

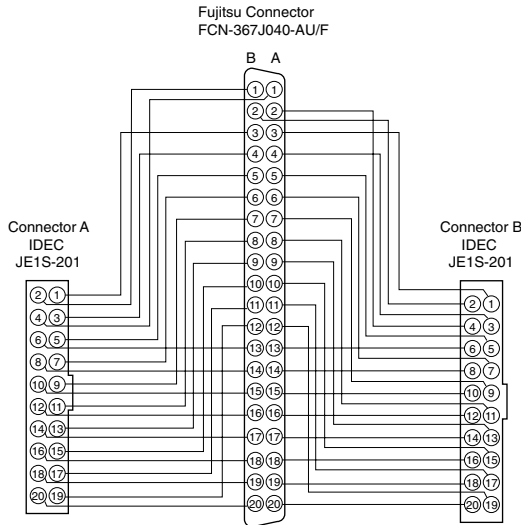

FC9Z-H□□□E4 Internal Connection

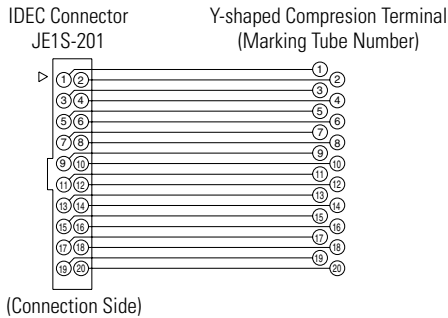

01 Touchscreens

PLCs

Automation Software

Power Supplies

Sensors

Communication

Barriers

Switches and Pilot Devices

General Specifications for Pilot Light, Illuminated Pushbutton, Illuminated Selector Switch, and Buzzer

Operating Temperature	-20 to +60°C (no freezing)	
Operating Humidity	45 to 85% RH (no condensation)	
Dielectric Strength (1 mA, 1 minute)	EB3P: 1000V AC IPL1: 500V AC (between intrinsically safe circuit and dead parts)	
Insulation Resistance	10 MΩ minimum (500V DC megger, between the same poles as the dielectric strength)	
Pilot Light and Miniature Pilot Light	Degree of Protection	IP65 (IEC60529) (except for terminals) EB3P-LU/IPL1: IP40
	Lens/Illumination Color	Pilot light: Amber, blue, green, red, white, yellow Miniature pilot light: Amber, green, red, white, yellow
	Intrinsic Safety Ratings and Parameters	1-channel Separate Wiring Maximum input voltage (Ui): 13.2V Maximum input current (Ii): 14.2 mA Maximum input power (Pi): 46.9 mW Internal capacitance (Ci): ≤ 2 nF Internal inductance (Li): ≤ 5 μH
		16-channel Common Wiring Maximum input voltage (Ui): 13.2V Maximum input current (Ii): 227.2 mA Maximum input power (Pi): 750 mW Internal capacitance (Ci): ≤ 32 nF Internal inductance (Li): ≤ 80 μH

Illuminated Switch	Degree of Protection	IP65 (IEC60529) (except for terminals) EB3P-LSAW**: IP54
	Illumination Color	Amber, blue, green, red, white, yellow
	Contact Voltage/Current	12V DC ±10%, 10 mA ±20% (when connecting to the EB3C)
Illuminated Switch	Intrinsic Safety Ratings and Parameters	16-channel Common Wiring Maximum input voltage (Ui): 13.2V Maximum input current (Ii): 227.2 mA Maximum input power (Pi): 750 mW Internal capacitance (Ci): ≤ 32 nF Internal inductance (Li): ≤ 80 μH
Buzzer	Degree of Protection	IP20 (IEC60529) (except for terminals)
	Sound Volume	75 dB minimum (at 1 m)
	Sound Source	Piezoelectric oscillator (continuous or intermittent)
	Intrinsic Safety Ratings and Parameters	1-channel Separate Wiring Maximum input voltage (Ui): 13.2V Maximum input current (Ii): 14.2 mA Maximum input power (Pi): 46.9 mW Internal capacitance (Ci): ≤ 260 nF Internal inductance (Li): ≤ 80 mH
Weight	100g	

 Note: Connect buzzers in separate wiring. Buzzers cannot be used in common wiring.

Part Numbers for Pilot Lights, Illuminated Pushbuttons, Illuminated Selector Switches, and Buzzers

Unit	Size	Series ¹	Shape	Operation Mode	Contact	Ordering Number	Lens Color/ Illumination Color Code*	Operation
Pilot Light	ø30	N	Dome	—	—	EB3P-LAN1-*	A: Amber G: Green R: Red S: Blue W: White ⁵ Y: Yellow	—
			Square	—	—	EB3P-LUN3B-*		
			Rectangular w/Metal Bezel	—	—	EB3P-LUN4-*		
			Dome w/Diecast Sleeve	—	—	EB3P-LAD1-*		
	ø22	TW	Flush	—	—	EB3P-LAW1-*		
			Flush(Marking Type)	—	—	EB3P-LAW1B-*		
			Dome	—	—	EB3P-LAW2-*		
		HW	Square Flush (Marking Type)	—	—	EB3P-LUW1B-*		
			Round Flush	—	—	EB3P-LHW1-*		
			Dome	—	—	EB3P-LHW2-*		
			Square Flush	—	—	EB3P-LHW4-*		
			LW	Round	—	—		
Square	—	—		EB3P-LLW2-*				
Round w/ Square Bezel	—	—		EB3P-LLW3-*				
Miniature Pilot Light	ø10	UP	Extended	—	—	IPL1-18-*	A: Amber G: Green R: Red W: White ⁵ Y: Yellow	—
			Dome	—	—	IPL1-19-*		
	ø8		Flush	—	—	IPL1-87-*		
	Extended		—	—	IPL1-88-*			
	Dome		—	—	IPL1-89-*			
	Flush		—	—	IPL1-67-*			
	ø6		Extended	—	—	IPL1-68-*		
			Dome	—	—	IPL1-69-*		

Part Numbers for Pilot Lights, Illuminated Pushbuttons, Illuminated Selector Switches, and Buzzers, con't

Unit	Size	Series ¹	Shape	Operation Mode	Contact	Ordering Number ²	Lens Color/ Illumination Color Code*	Operation		
Illuminated Pushbutton	ø30	N	Extended	Momentary	1NO-1NC	EB3P-LBAN211-*	A: Amber G: Green R: Red S: Blue W: White ⁵ Y: Yellow	—		
				Maintained	1NO-1NC	EB3P-LBAON211-*				
			Mushroom	Pushlock Turn Reset	1NO-1NC	EB3P-LBAVN311-R			Red only	
	ø22	TW	Extended	Momentary	1NO-1NC	EB3P-LBAW211-*	A: Amber G: Green R: Red S: Blue W: White ⁵ Y: Yellow			
				Maintained	1NO-1NC	EB3P-LBAOW211-*				
			Mushroom	Pushlock Turn Reset	1NO-1NC	EB3P-LBAVW411-R			Red only	
		HW	Round	Momentary	1NO	EB3P-LBH1W110-*	A: Amber G: Green R: Red S: Blue W: White ⁵ Y: Yellow			
				Maintained	1NO	EB3P-LBHA1W110-*				
		LW	Round	Momentary	DPDT	EB3P-LBL1W1C2-*				
	Maintained			DPDT	EB3P-LBLA1W1C2-*					
	Square		Momentary	DPDT	EB3P-LBL2W1C2-*					
			Maintained	DPDT	EB3P-LBLA2W1C2-*					
Illuminated Selector Switch ³	ø30	N	Round	2-position	1NO-1NC	EB3P-LSAN211-*		A: Amber G: Green R: Red S: Blue W: White ⁵ Y: Yellow	Maintained	
				3-position	2NO	EB3P-LSAN320-*			Maintained	
				2-position	1NO-1NC	EB3P-LSAW211-*			Maintained	
	ø22	TW	Round	2-position, return from right	1NO-1NC	EB3P-LSAW2111-*			Spring return from right	
				3-position	2NO	EB3P-LSAW320-*			Maintained	
				3-position, return from right	2NO	EB3P-LSAW3120-*			Spring return from right	
				3-position, return from left	2NO	EB3P-LSAW3220-*	Spring return from left			
				3-position, 2-way return	2NO	EB3P-LSAW3320-*	2-way spring return			
				2-position	1NO-1NC	EB3P-LSHW211-*	Maintained			
	HW	Round	3-position	2NO	EB3P-LSHW320-*	Maintained				
			LW	Round	2-position	DPDT	EB3P-LSL1W2C2-*		Maintained	
					Round w/Square Bezel	3-position	DPDT		EB3P-LSL3W3C2-*	Maintained
	Buzzer	ø30	—	—	Continuous sound	—	EB3P-ZUN12CN		—	Approx. 3 Hz
					Intermittent sound	—	EB3P-ZUN12FN			

1. Codes N, TW, HW, LW, and UP are the series names of IDEC's control units.
2. Specify a color code in place of *.
3. Above parts are recommended for EB3L barriers. However, none of these parts are UL recognized.
4. Buzzers are not rated for Zone 0, but only Zones 1 and 2.
5. Use PW (pure white) LED for yellow lenses

Accessory

Name	Ordering Number	Package Quantity	Remarks
LED Lamp	EB9Z-LDS1-*	1	Specify a color code in place of * in the ordering number. A: amber, G: green, R: red, S: blue, W: white, PW: pure white (for yellow use PW with yellow lens) Use PW (pure white) LED for yellow lenses
Static Electricity Caution Plate	EB9Z-N1PN10	10	Polyester 20(W) x 6(H) mm

 Above part is recommended for EB3L barriers. However, this part is not UL recognized.

OI Touchscreens
PLCs
Automation Software
Power Supplies
Sensors
Communication

Barriers

Pilot Lights

ø30 EB3P-LAN1
Terminal Cover: APN-PVL
(sold separately)

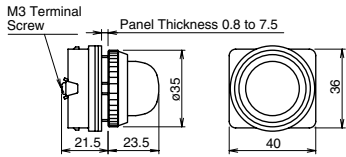

ø30 EB3P-LUN4
Terminal Cover: APN-PVL
(sold separately)

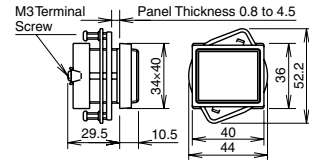

ø30 EB3P-LAD
Terminal Cover: APD-PVL
(sold separately)

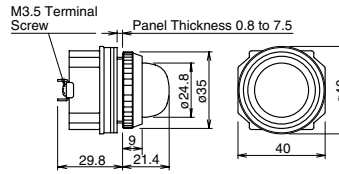

ø30 EB3P-LUN3B
Terminal Cover: APN-PVL
(sold separately)

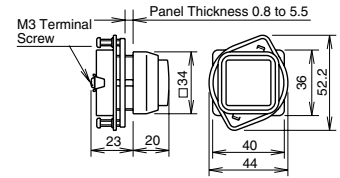

ø22 EB3P-LAW1

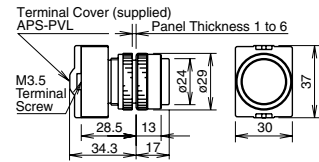

ø22 EB3P-LAW1B

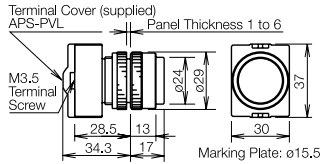

ø22 EB3P-LAW2

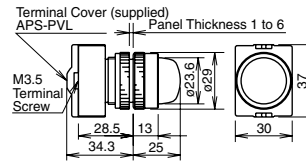

ø22 EB3P-LUW1B

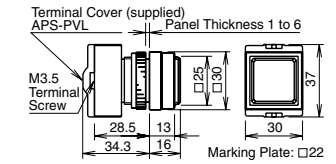

ø22 EB3P-LHW1/EB3P-LHW2/EB3P-LHW4
Terminal cover attached.

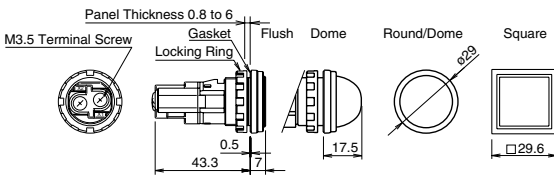

ø22 EB3P-LLW1/EB3P-LLW2/EB3P-LLW3
Terminal cover attached.

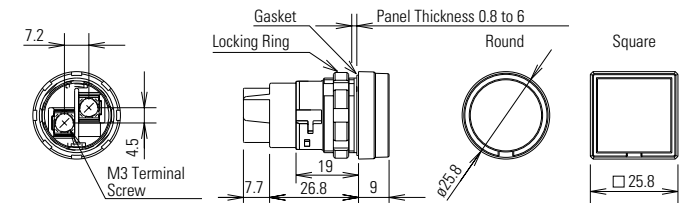

Miniature Pilot Lights (Terminal cover not available)

ø10 IPL1-18

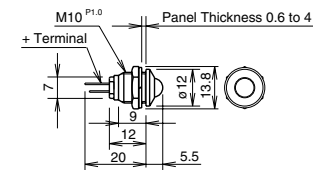

ø10 IPL1-19

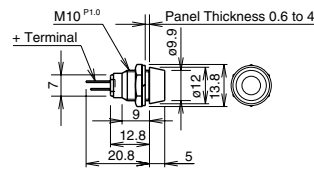

ø8 IPL1-87

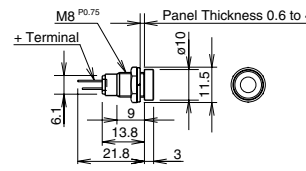

ø8 IPL1-88

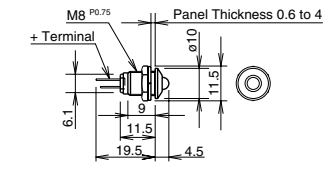

ø8 IPL1-89

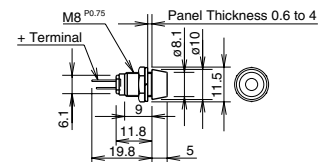

ø6 IPL1-67

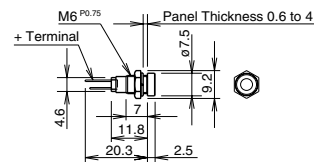

ø6 IPL1-68

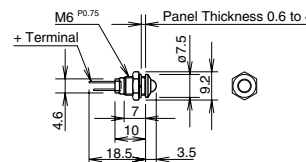

ø6 IPL1-69

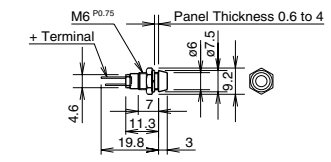

OT Touchscreens

PLCs

Automation Software

Power Supplies

Sensors

Communication

Barriers

Illuminated Pushbuttons

ø30 EB3P-LBAN211/LBAON211
Terminal cover: N-VL4 (2 pcs.) (sold separately)

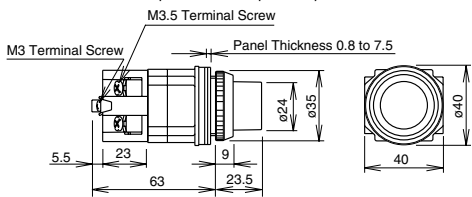

ø30 EB3P-LBAVN311-R
Terminal cover: N-VL4 (2 pcs.) (sold separately)

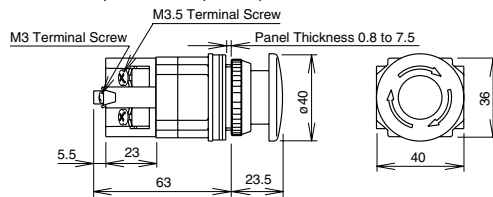

ø22 EB3P-LBAW211/LBAOW211
Terminal cover attached.

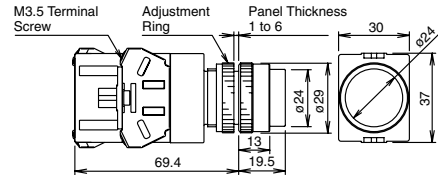

ø22 EB3P-LBAVW411-R
Terminal cover attached.

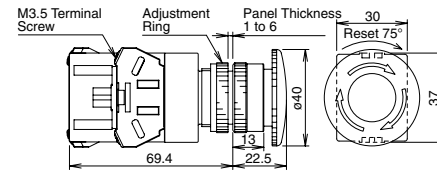

ø22 EB3P-LBH1W110/LBHA1W110
Terminal cover attached.

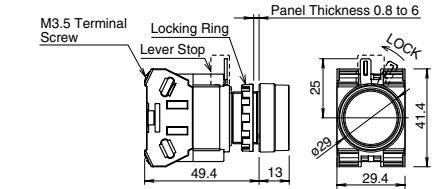

ø22 EB3P-LBL1W1C2/LBLA1W1C2
Terminal cover: LW-VL2M (sold separately)

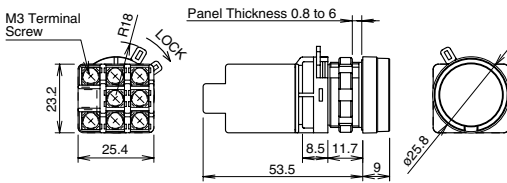

ø22 EB3P-LBL2W1C2/LBLA2W1C2
Terminal cover: LW-VL2M (sold separately)

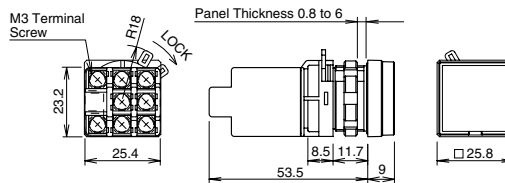

All dimensions in mm.

Illuminated Selector Switches

ø30 EB3P-LSAN211/EB3P-LSAN320
Terminal cover: N-VL4 (2 pcs.) (sold separately)

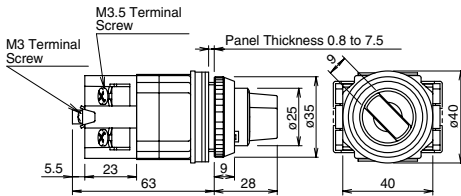

ø22 EB3P-LSAW***
Terminal cover attached

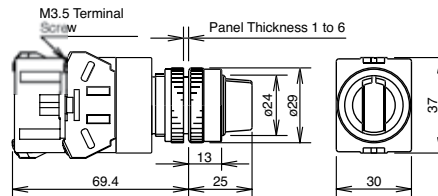

ø22 EB3P-LSHW211/EB3P-LSHW320
Terminal cover attached

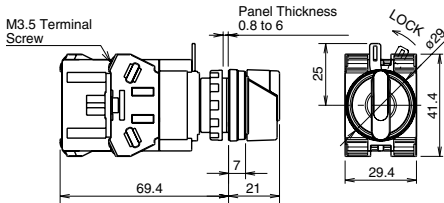

ø22 EB3P-LSL1W2C2/EB3P-LSL3W3C2
Terminal cover: LW-VL2M (sold separately)

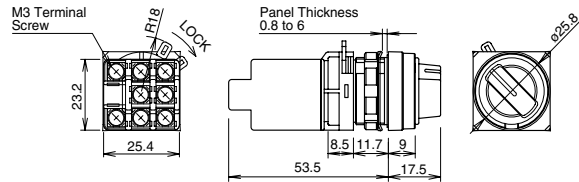

Buzzer

ø30 EB3P-ZUN12CN/ZUN12FN
Terminal cover: AZ-VL5 (sold separately)

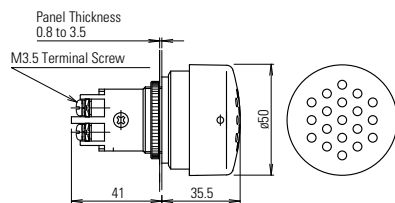

EB9Z-LDS1

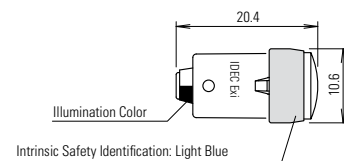

Illumination color is marked on the terminal.

01 Touchscreens

PLCs

Automation Software

Power Supplies

Sensors

Communication

Barriers

Polarity Identification

Pilot Lights/Illuminated Pushbuttons/Illuminated Selector Switches

Positive terminal: X1
 Negative terminal: X2

Miniature Pilot Lights

Positive terminal: Long pin terminal
 Negative terminal: Short pin terminal

Pin Terminals

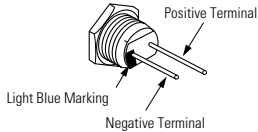

A light blue marking is indicated on the negative terminal side to identify intrinsically safe usage.

Buzzer

Positive terminal: +
 Negative terminal: -

LED Lamp

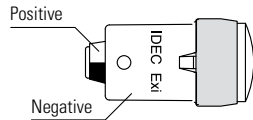

Lamp Test

When checking the lamp lighting without using the EB3L discrete output barrier, first make sure that the atmosphere is free from explosive gases. Connect a 12V DC power supply and a protection resistor of 1 kΩ in series to turn on the pilot light.

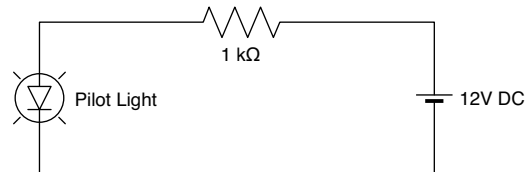

Precautions for Operation

Installation of EB3L Discrete Output Barriers

1. The EB3L can be installed in any direction.
2. Install the EB3L discrete output barrier in a safe area (non-hazardous area) in accordance with intrinsic safety ratings and parameters. To avoid mechanical shocks, install the EB3L in an enclosure which suppresses shocks.
3. When installing or wiring the EB3L, prevent electromagnetic and electrostatic inductions in the intrinsically safe circuit. Also prevent the intrinsically safe circuits from contacting with another intrinsically safe circuit and any other circuits.

Maintain at least 50 mm clearance, or provide a metallic separating board between the intrinsically safe circuit and non-intrinsically safety circuit. When providing a metallic separating board, make sure that the board fits closely to the enclosure (top, bottom, and both sides). Allowable clearance between the enclosure and board is 1.5 mm at the maximum.

The clearance of 50 mm between the intrinsically safe circuit and non-intrinsically safe circuit may not be sufficient when a motor circuit or high-voltage circuit is installed nearby. In this case, provide a wider clearance between the circuits referring to 6. (3) "Minimum Parallel Distance between the Intrinsically Safe Circuit and Other Circuits."

**Panel Cut-out
 Pilot Lights/Illuminated Pushbuttons/Illuminated Selector Switches/Buzzers**

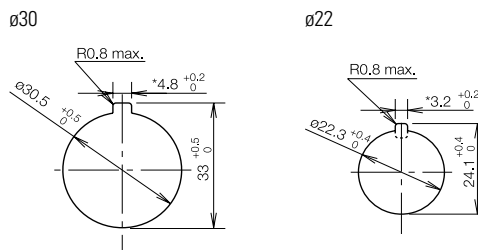

Miniature Pilot Lights

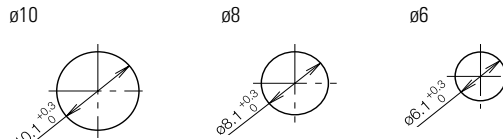

* The 4.8 or 3.2 recess is needed only when using an anti-rotation ring or a nameplate with an anti-rotation projection. EB3P-LHW does not have an anti-rotation groove.

All dimensions in mm.

4. In order to prevent contact between intrinsically safe circuits and non-intrinsically safe circuits, mount EB3L units with terminals arranged in the same direction.

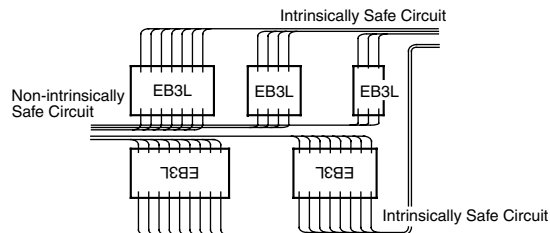

5. Maintain at least 6 mm (or 3 mm according to IEC60079-11: 1999) clearance between the terminal of intrinsically safe circuit and the grounded metal part of a metal enclosure, and between the relay terminal block of an intrinsically safe circuit and the grounded metal part of a metal enclosure.
6. For installing the EB3L, mount on a 35-mm-wide DIN rail or directly on a panel using screws. The EB3L can be installed in any direction. Make sure to install securely to withstand vibration. When mounting on a DIN rail, push in the clamp completely. Use the BNL6 end clips on both sides of the EB3L to prevent from moving sideways.
7. Excessive extraneous noise may cause malfunction and damage to the EB3L. When extraneous noise activates the voltage limiting circuit (thyristor), remove the noise source and restore the power.

Terminal Wiring

- Using a $\phi 5.5$ mm or smaller screw driver, tighten the terminal screws (including unused terminal screws) to a torque of 0.6 to 1.0 N·m (recommended value).
- Make sure that IP20 is achieved when wiring. Use insulation tubes on bare crimping terminals.
- To prevent disengaged wires from contacting with other intrinsically safe circuits, bind together the wires of one intrinsically safe circuit.
- When the adjacent terminal is connected to another intrinsically safe circuit, provide an insulation distance of at least 6 mm.

Signal Input

- Connect the EB3L to the switches or output equipment which have a low leakage current (0.1 mA maximum).
- The EB3L is equipped with power supply. Do not apply external power to the EB3L.
- When connecting the EB3L's of connector type in parallel, make sure that the same power supply is used. When using C1 and C2 terminals to supply power to outside equipment, maintain the current at 50 mA maximum.

Power Voltage

- Do not apply an excessive power voltage, otherwise the EB3L may be damaged.
- The EB3L of AC power type may operate at a low voltage (approx. 20V).

Pilot Lights, Illuminated Switches, and Buzzers in the Hazardous Area

- EB3P and IPL1 units shown on page 269 can be used with the EB3L. Buzzers cannot be connected in common wiring.
- Install the EB3P and IPL1 units on enclosures of IP20 or higher protection. Use a metallic enclosure with magnesium content of 7.5% or less (steel and aluminum are acceptable).
- When wiring, make sure of correct polarities of the EB3P and IPL1.
- Certification mark is supplied with the units. Attach it on the visible area of the EB3P or IPL1 (for Japan application).
- EB3P (except for buzzers) and IPL1 illuminated units, which are simple apparatuses in accordance with relevant standards of each country, can be installed in the hazardous area and connected to the EB3L located in the safe area.
- When connecting illuminated switches to the EB3L discrete output barrier and the EB3C discrete input barrier, a maximum of 16 channels can be connected in common wiring.

Wiring for Intrinsic Safety

- The voltage applied on the general circuit connected to the non-intrinsically safe circuit terminals of the EB3L discrete output barrier must be 250V AC, 50/60Hz (UL rating: 125V AC 50/60Hz), or 250V DC (UL rating: 125V DC) at the maximum under any conditions, including the voltage of the power line and the internal circuit.
- When wiring, take into consideration the prevention of electromagnetic and electrostatic charges on intrinsically safe circuits. Also, prevent intrinsically

safe circuits from contacting with other circuits.

- The intrinsically safe circuits must be separated from non-intrinsically safe circuits. Contain intrinsically safe circuits in a metallic tube or duct, or separate the intrinsically safe circuits referring to the table at right.

Note: Cables with a magnetic shield, such as a metallic sheath, prevent electromagnetic induction and electrostatic induction, however, a non-magnetic shield prevents electrostatic induction only. For non-magnetic shields, take a preventive measure against electromagnetic induction.

Finely twisted pair cables prevent electromagnetic induction. Adding shields to the twisted pair cables provides protection against electrostatic induction.

Voltage and Current of Other Circuits	Over 100A	100A or less	50A or less	10A or less
Over 440V	2000	2000	2000	2000
440V or less	2000	600	600	600
220V or less	2000	600	600	500
110V or less	2000	600	500	300
60V or less	2000	500	300	150

Note: Above chart is applicable under TIS standards only.

Minimum Parallel Distance between the Intrinsically Safe Circuit and Other Circuits (mm)

- When identifying intrinsically safe circuits by color, use light blue terminal blocks and cables.
- When using two or more EB3L's to set up one intrinsically safe circuit in the common wiring configuration, interconnect two neutral terminals (N1 through N10) on each EB3L between adjacent EB3L's in parallel.
- Make sure that the power of the EB3L, pilot lights, and other connected units are turned off before starting inspection or replacement.
- When wiring the intrinsically safe circuit, determine the distance to satisfy the wiring parameters shown below. Note that parameters are different between separate wiring and common wiring and depend on the connected units, such as pilot lights, illuminated pushbuttons, and buzzers.
 - Wiring capacitance $C_w \leq C_o - C_i$
 Co: Maximum external capacitance of the EB3L
 Ci: Internal capacitance of the connected unit
 - Wiring inductance $L_w \leq L_o - L_i$
 Lo: Maximum external inductance of the EB3L
 Li: Internal inductance of the connected unit
 - Wiring resistance $\leq R_w$
 Rw: Allowable wiring resistance
 - Allowable wiring distance D (km) is the smallest value of those calculated from the capacitance, inductance, and resistance.

$D \leq C_w/C$ C (nF/km): Capacitance of cable per km
 $D \leq L_w/L$ L (mH/km): Inductance of cable per km
 $D \leq R_w/2R$ R (Ω /km): Resistance of cable per km

Note: For the details of wiring the intrinsically safe circuits, refer to a relevant test guideline for explosion-proof electric equipment in each country.

Safety Precautions

Do not use the EB3C Discrete Input Barrier and EB3L Discrete Output Barrier for other than explosion protection purposes.

Read the user's manual to make sure of correct operation before starting installation, wiring, operation, maintenance, and inspection of the EB3C Discrete Input Barrier and EB3L Discrete Output Barrier.

General Information

What is Explosion Protection?

Explosion Mechanism

For an explosion to occur, both hazardous atmosphere (mixture of explosive gas/vapor and air) and ignition source from electrical equipment must exist. The first step for explosion prevention is to prevent the three factors (explosive gas/vapor, air, and ignition source) from existing at the same time.

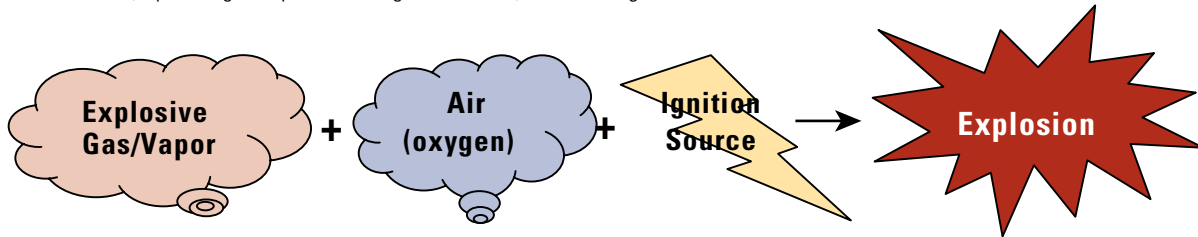

Ignition source: Electrical equipment which originates electrical sparks or has a high temperature, capable of causing ignition in a hazardous atmosphere.

Explosion protection types:

1. Separation of explosive gas/vapor and ignition source
 - Flameproof explosion protection
 - Pressurized explosion protection
2. Low power on ignition source → Intrinsically safe explosion protection

Classification of Hazardous Areas

- Required when selecting explosion protection electrical equipment and wiring methods.
- Determined by user.
- Hazardous areas are classified depending on the frequency of the occurrence of hazardous atmosphere.

IEC Classification

Zone 0: Where hazardous atmosphere may exist for 1,000 hours or longer per year.

Zone 1: Where hazardous atmosphere may exist for 10 to 1,000 hours per year.

Zone 2: Where hazardous atmosphere may exist for less than 1 hour per year.

Gasoline Tank Example

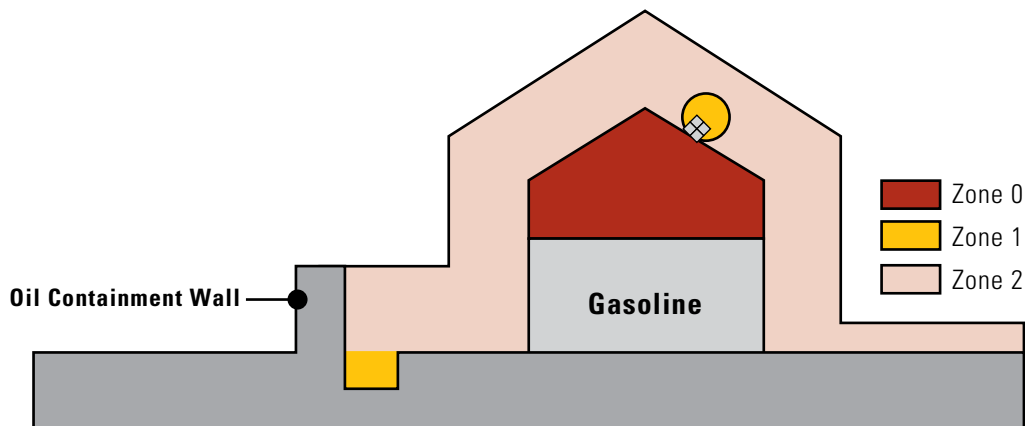

Explosion Protection Types

Intrinsically Safe Structure

- Structure in which voltage and current are limited so that no sparks, arc, and thermal effect produced by electric equipment (switch, pilot light, etc) in hazardous areas are capable of causing ignition of explosive gas/vapor.

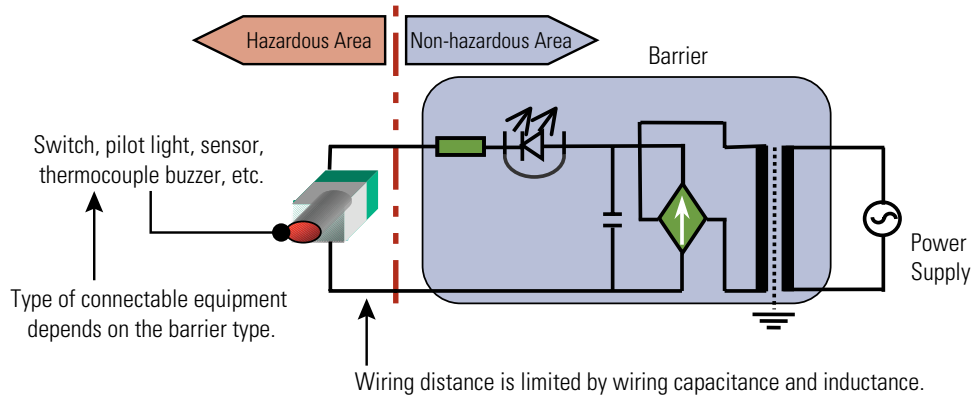

Features:

- Barrier is installed in non-hazardous area, and is connected to the switches or pilot lights in hazardous area.
- The intrinsically safe system can be used in zone 0.
- Because voltage and current to the electric equipment are limited, the variety of devices that can be connected to the barrier is restricted.
- Wiring is required between hazardous and non-hazardous areas.
- Grounding (grounding resistance 10Ω max.) may be required (EB3C, EB3L do not require grounding).

Grounding - The procedure to achieve required resistance value by inserting a grounding wire into a hole in the ground and furnishing the surrounding with material of superior electrical conductivity.

Non-insulated barrier (Zener barrier): grounding resistance 10Ω max.

- While the voltage difference between the circuits is limited in Zener barriers, the voltage difference between the circuits and grounding is unlimited. When a short-circuit occurs between the circuits and ground, high voltage/current may be generated in the circuits, causing a possible explosion. The OV line of circuits, therefore, must be provided with grounding (resistance 10Ω max.) so that the voltage/current can be shunted to the ground.

Insulated barrier: grounding resistance 100Ω max.

- Intrinsically safe and non-intrinsically safe parts are electrically isolated by an isolation transformer. If a sufficient isolation distance is not provided on the isolation transformer, however, the transformer may short-circuit between primary and secondary when an abnormal voltage occurs. This may generate high voltage/current in the intrinsically safe circuit, causing a possible explosion. A transformer with metallic isolator must be used between primary and secondary, and grounding (resistance 100Ω max.) must be provided.

Difference between NI (Non-incendive) & IS (Intrinsic Safety)

Standard

- NI: Installed in areas that are Zone 2 hazardous locations.
- IS: Installed in areas that are non-hazardous.

Advantages & Disadvantages

- NI: Small and inexpensive. Devices connected with NI are also installed only in the Zone 2 area.
- IS: Small but more expensive. Devices connected with IS can be used in the Zone 0, 1 and 2 areas (all zones).

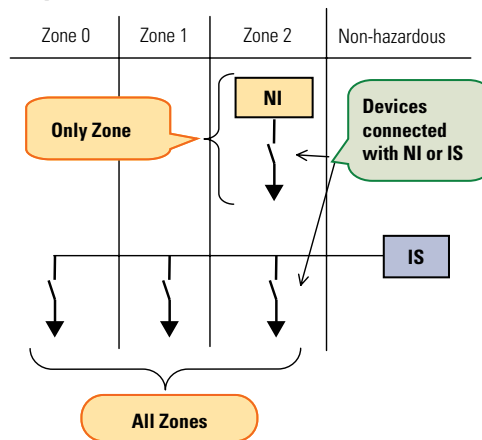

OI Touchscreens

PLCs

Automation Software

Power Supplies

Sensors

Communication

Barriers

Structure

NI Structure

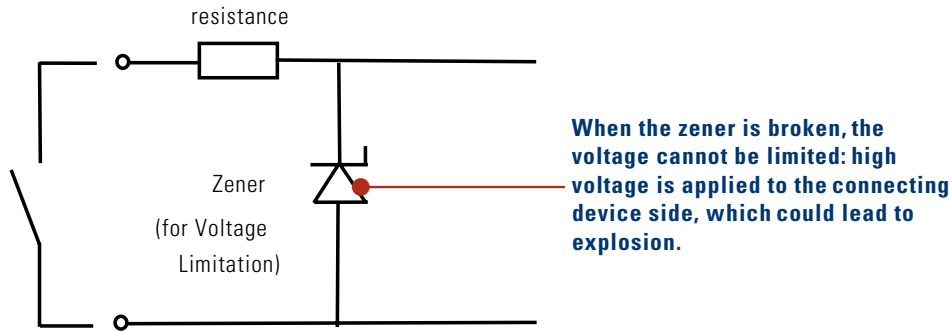

IS Structure

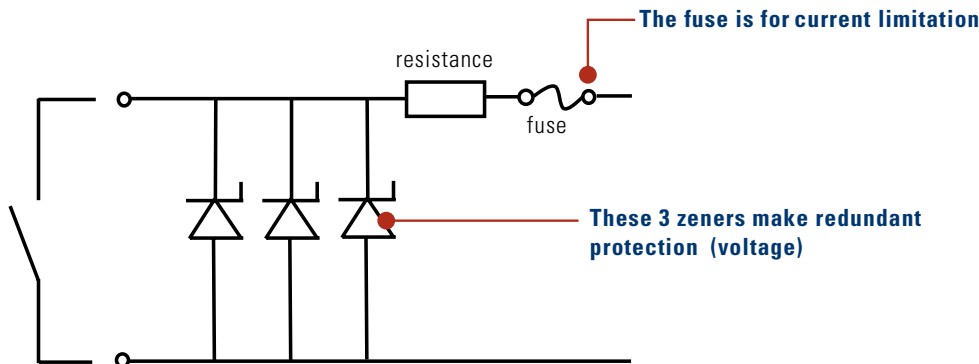

 Note : Instead of zeners, thyristors are used in EB3C for better energy efficiency.

Explosion Protection Marking

Gas is categorized into groups by explosiveness and ignition temperature.

Technical standard: Determines the gas type which can be used with the apparatus.

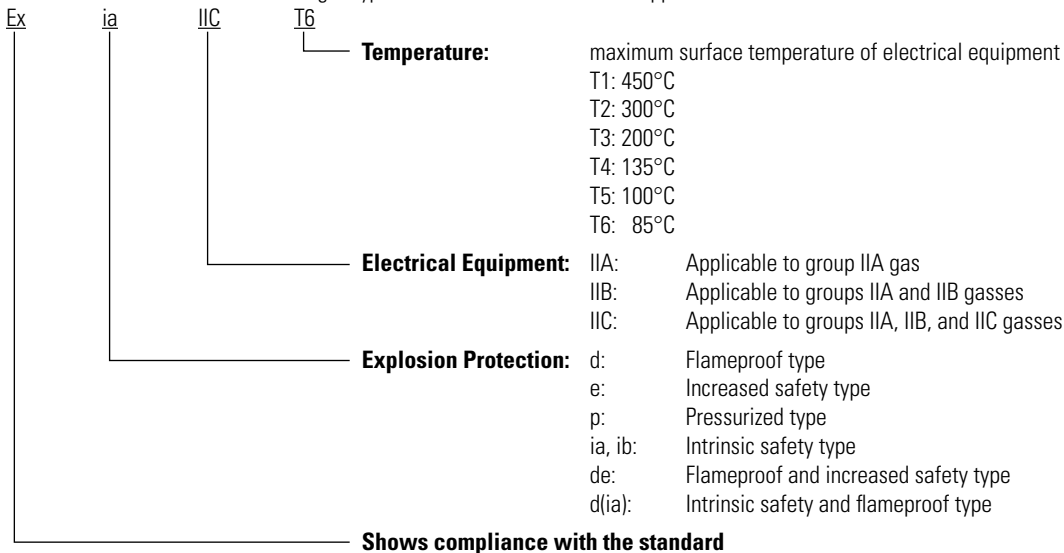

Examples: ExdIIBT4, EXeIICT4, ExlIBT4, ExialICT5

EB3C/EB3L Features

01 Touchscreens

Small and lightweight

EB3C (10-circuit)	Weight: 380g Dimensions: 171.5 L × 75 W × 77.5 H (mm)	<ul style="list-style-type: none"> • Plastic housing • Small system design
EB3L (10-circuit)	Weight: 360g Dimensions: 171.5 L × 75 W × 77.5 H (mm)	

PLCs

No grounding required: less labor, less cost

No explosion protection grounding.

Isolation transformer is used. All isolations – not only between primary and secondary, but also cores and bobbins – are reinforced.

↓

No isolator = No grounding

Automation Software

No electrical equipment grounding.

Power supply part:	Electric shock is prevented with reinforced isolation. Conforms to IEC standard.
Output part:	The small power & EMC design requires no grounding. Conforms to IEC switch output standard.

Shield wire treatment

Shield wires of intrinsically safe circuits are grounded to the panel in non-hazardous area, and not connected to the N terminal on the barrier.

Power Supplies

Common Type and Connector Type

1. Common type → For 8 and 16 circuits. Easy connection to PLC.
2. Connector type
 - Flat cable connection between non-intrinsically safe part and PLC.
 - Connectable to IDEC's FC5A, and FC4A.

Sensors

Communication

Barriers

Standards

1. CE
Conforms to EMC directive and LVD.
EMC directive:
Electromagnetism generated by the barrier does not affect other communication equipment. Also, electromagnetism generated by other communication equipment does not affect the barrier.
LVD (Low Voltage Directive):
For rated voltages 50 to 1000V AC, 75 to 1500V DC.
2. ATEX
Adopted by EU, this directive covers electrical and mechanical equipment and protective systems, which may be used in potentially explosive atmospheres (Europe). EN50014 series is adopted.
3. FM (Factory Mutual Approval)
A private US certification organization for waterproof and intrinsic safety. Widely recognized for more intrinsic safety than UL.
4. CSA (Canadian Standards Association)
A Canadian certification organization for electrical equipment.
5. NK: Class NK (Nippon Kaiji Kyokai)
Required for ships with Japanese ship registration.
6. Underwriters Laboratories (UL) - A US certification agency for all electrical and hazardous location products.

Less labor

1. Finger-safe spring-up terminal
The finger-safe, captive spring-up terminals prevent electric shock (IP20), and make installation easy. No screw loss.
2. Universal voltage
100 to 240V AC (UL rating 100 ~ 120VAC).
3. Installation
Direct and DIN-rail mountable.

EB3 series: Screws cannot be touched by fingers even when loosened.

Switches connectable to EB3C

Switches which are configured only with mechanical contacts (dry contacts) can be connected to the EB3C.

Pushbutton, selector, cam, toggle, limit, micro, reed, foot, pressure, and temperature switches can be used.



Note: Contact rating must be 13.2V, 14.2 mA minimum. Contact material such as silver oxide cadmium and silver tungsten may cause conduction failure at 10 mA due to the film generated on the surface.

Equipment connectable to EB3L

Common wiring: Only EB3P-L type pilot lights, which have been approved, can be connected to the EB3L discrete output barrier.

Separate wiring: No approval is required for pilot lights and buzzers to be connected to the EB3L discrete output barrier. However, users must make sure that the temperature rise of the equipment is below the rated value with the current and voltage supplied from the discrete input barrier. Also take the ratings of intrinsically safe circuit into consideration. IDEC's EB3P-L type pilot light lights and EB3P-Z type buzzers satisfy the ratings.

EB3P-L Pilot light: $\varnothing 22$ and $\varnothing 30$, a total of 78 types

- Super LED installed
- Lens colors: amber, blue, green, red, white, and yellow
- Accessories and maintenance parts are the same as standard control units. See IDEC's control units catalogs.

IPL1 Miniature pilot light: $\varnothing 6$, $\varnothing 8$, and $\varnothing 10$, a total of 40 types

- Low price
- Illumination colors: amber, green, red, white, and yellow

EB3P-Z buzzer: Continuous and intermittent sound, $\varnothing 30$ mounting hole, terminal block type

- Degree of protection: IP20
- Common wiring is not available due to high inductance value.
- Approved by THS only

$\varnothing 30$: APN, UPQN equivalent
 $\varnothing 22$: APW, HW, LW, UPQW equivalent



When connecting one buzzer and 15 pilot lights to EB3L-S16CSD, do not connect the negative lines of buzzer and pilot lights in common. Connect the buzzer and pilot lights to the barrier using separate lines (15 pilot lights can be wired with one common line).

Connecting Illuminated Switches

Made possible with the combination of EB3L and EB3C.

User benefits

- Flexibility of control panel design
Explosion protected panels can be designed in a similar manner to non-explosion protected panels (non-explosion protected panels can be used as explosion protected panels without any changes).
- Control panel becomes smaller.

Connectable illuminated switch: 134 types

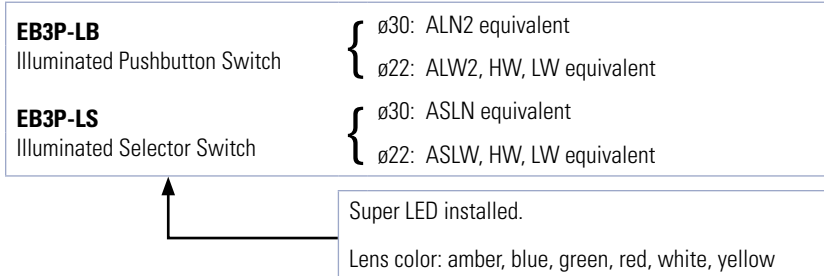

Connection Method

1. Difference between EB3C and EB3L

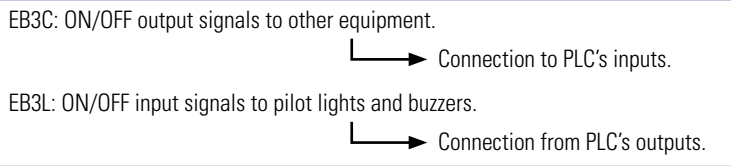

2. Sink and Source

Available combination: Sink Output + Source Input or Source Output + Sink Input. Sink output (source input) is mainly adopted in Japan (Europe: source output).

Other information

- Up to 16 channels, including both pilot lights and contacts, can be connected in common wiring.
- Connect the common wires of pilot lights and contacts separately to the N terminals of each barrier.
- Use two wires to connect the common terminals (N terminals) EB3C and EB3L barriers.
- Accessories and maintenance parts are the same as the standard control units. See IDEC's control units catalogs for details.

Safety Precautions

Electrostatic protection: Prevention of fire ignition and explosion caused by electrostatic charges.

- As required by IEC60079-11, limit the exposed surface of plastic equipment (switch, pilot light) installed in hazardous areas.
- 20 cm² max. for IIC gas atmosphere.
- 100 cm² max. for IIB and IIA gas atmosphere.
- When the surface area of other than operating parts exceeds the limit, attach a caution plate.
- Pushbutton, knob, or other parts which are frequently touched by operators.

EB3C Separate and Common Types

1. Separate Wiring Type

The output circuit is isolated for each channel. Both sink and source outputs can be connected.

2. Common Wiring Type

The output circuit is not isolated from each other and uses common terminal C. Sink and source outputs are available on different modules.

OI Touchscreens

PLCs

Automation Software

Power Supplies

Sensors

Communication

Barriers

Sink/Source Definition

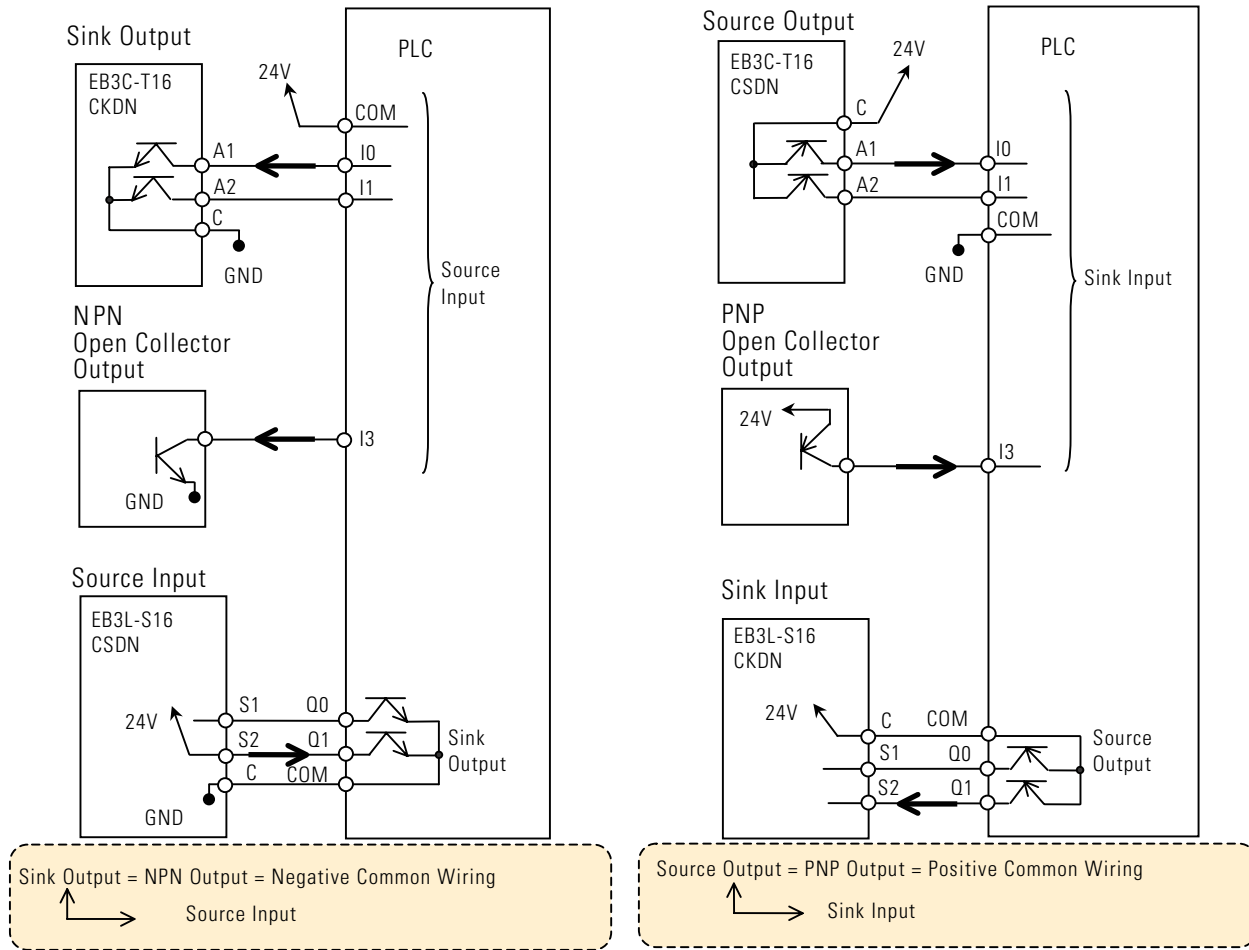

Relay Terminal Block

When connecting a discrete input barrier to the switches and pilot lights installed in hazardous area, use a relay terminal block.



A relay terminal block can be eliminated when using EB3C and EB3L, as these barriers are considered as relay terminal blocks.

Cable Extension and Intrinsic Safety Parameter

- For wiring between the barrier and the switches and pilot lights installed in hazardous area, use a cable of 2.0 mm². The cable can be extended up to approximately 1 km.
- For EB3L of common wiring type, use a cable of 2.0 mm². The cable can be extended up to approximately 600 m. Longer cables cause dim LED lighting.



Make sure that wiring parameters (inductance, capacitance, resistance) do not exceed the maximum limit.

Noise Countermeasure

- The LED connected to the EB3L may blink due to noises.
- Check the wiring so that noise is not imposed on the EB3L (eg. separation from power line).
- Noise can be avoided also by inserting a noise filter for AC line into the barrier's power input part.

Recommended noise filters:

TDK-Lambda			Schaffner
RSEL-2002W	RSEL-2002A	ZCB2203-11 => RSEL-2003A	FN670-3/06
RSEL-2003W	RSEL-2003A	ZCB2206-11 => RSEL-2006A	
RSEL-2006W	RSEL-2006		