

Selection Guide.....	26
High Performance Series.....	28
HG2G-5T Series.....	33
Automation Organizer Suite.....	34
Supported Drivers.....	35
Part Numbers.....	42
Accessories.....	44
Cables.....	46
Specifications.....	47
Dimensions.....	51

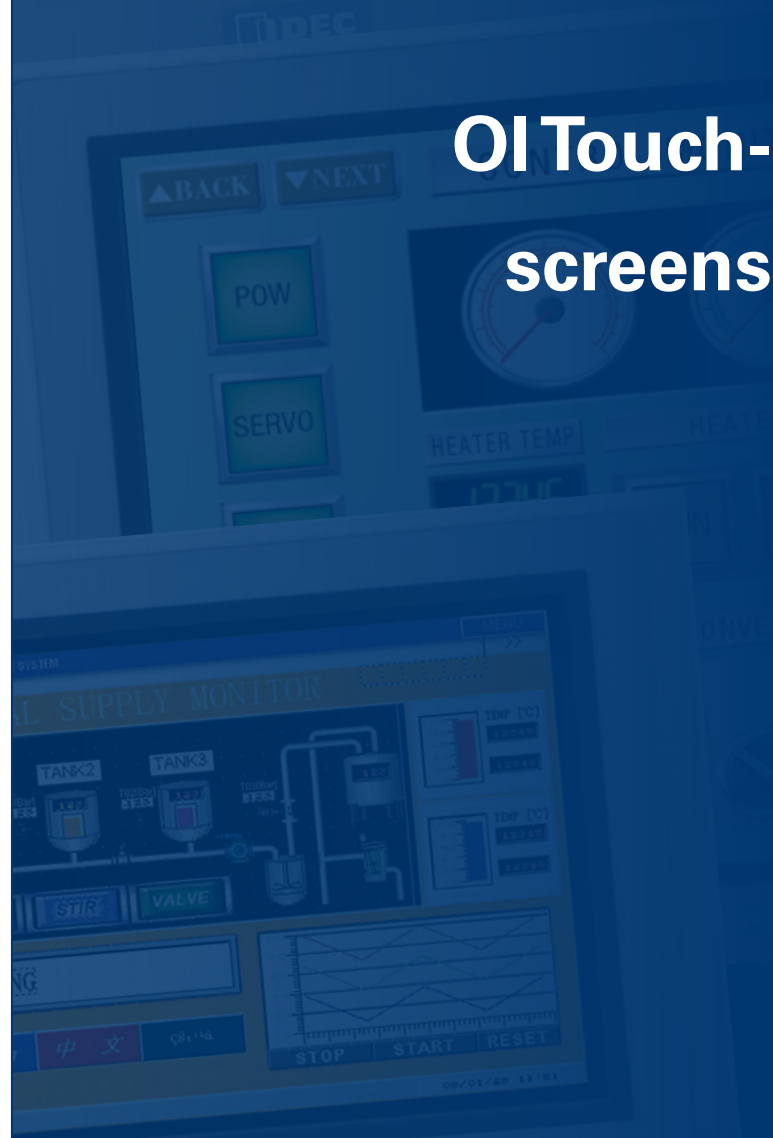

www.IDEC.com/oi

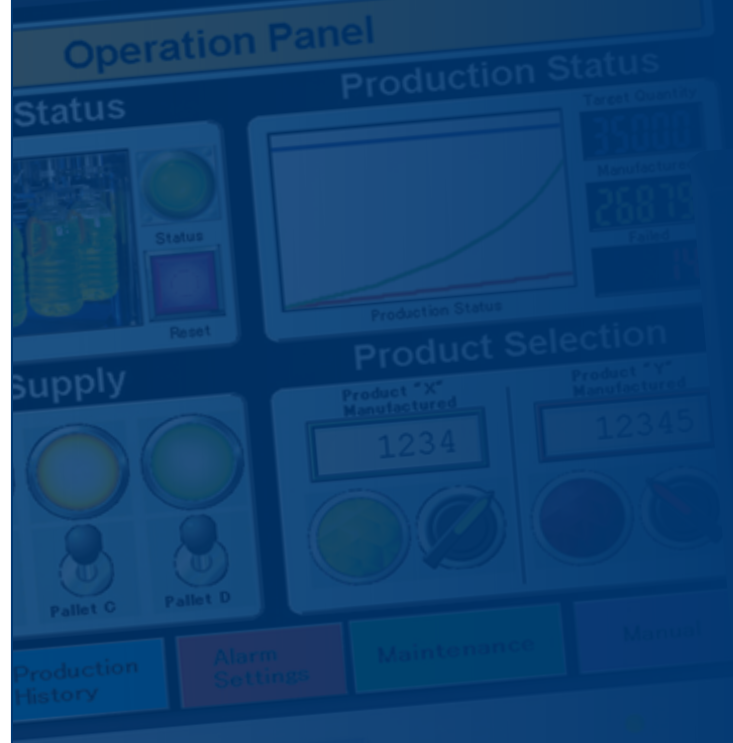

OITouch- screens

OITouchscreens

PLCs

Automation Software





Power Supplies

Sensors

Communication

Barriers



Selection Guide

		High Performance Series			
		5.7"	8.4"	10.4"	12.1"
					
Display Type		Color-TFT	Color-TFT	Color-TFT	Color-TFT
Color Depth		65,536	65,536	65,536	65,536
Rated Power Voltage		24VDC	24VDC	24VDC	24VDC
Resolution		640 x 480	800 x 600	800 x 600	800 x 600
Mount Portrait or Landscape		✓	✓	✓	✓
Brightness (cd / m ²)		800	600	700	550
SD Card Slot		✓	✓	✓	✓
Expansion I/O module		✓	✓	✓	✓
Serial Ports		2 (RS232, RS485,RS422)	2 (RS232, RS485,RS422)	2 (RS232, RS485,RS422)	2 (RS232, RS485,RS422)
Ethernet Port (1 RJ-45)		Standard	Standard	Standard	Standard
USB Ports		1 TypeA / 1 MiniB	1 TypeA / 1 Mini B	1 TypeA / 1 MiniB	1 TypeA / 1 MiniB
Video In *1		-	✓	✓	✓
Audio In/Out *2		-	Audio In/Out	Audio In/Out	Audio In/Out
Remote Control / Monitor		✓	✓	✓	✓
Approvals		IP66,UL 508, CSA C22.2 No.142, ABS, LR, NK, Type 4X and 13 Class I Div 2	IP66, UL508, CSA C22.2 No.142/213, ANSI/ISA-12.12.01-2007, ABS, LR, NK, Type 4X and 13 Class I Div 2	IP66, UL508, CSA C22.2 No.142/213, ANSI/ISA-12.12.01-2007, ABS, LR, NK, Type 4X and 13 Class I Div 2	IP66,UL508, CSA C22.2 No.142, ANSI/ISA-12 12.01-2007, ABS, LR, NK Type 4X and 13 Class I Div 2
Bezel	Light Gray Black Silver	HG2G-5FT22TF-W HG2G-5FT22TF-B HG2G-5FT22TF-S	HG3G-8JT22MF-W HG3G-8JT22MF-B -	HG3G-AJT22MF-W HG3G-AJT22MF-B -	- HG4G-CJT22MF-B -

*1. Composite Video RCA connector (NTSC or PAL).

*2. 3.5mm audio mini jack(stereo).

*3. Calendar, Battery Life and Power Failure Backup Data are not available for HG2G-5ST22VF

		Basic Series	HG2G-5T Series	
		4.6"	5.7"	
				
Display Type		Monochrome	Monochrome	Color-TFT
Color Depth		2	2	65,536
Rated Power Voltage		24VDC	12 to 24VDC	12 to 24 VDC
Resolution		300 x 100	320 x 240	320 x 240
Mount Portrait or Landscape		✓	✓	✓
Brightness (cd / m ²)		500	1100	500
SD Card Slot		-	-	-
Expansion I/O module		-	-	-
Serial Ports		RS232 RS485(422)	RS232, RS485,RS422	RS232, RS485,RS422
Ethernet Port (1 RJ-45)			Standard	Standard
USB Ports			1 TypeA / 1 MiniB	1 TypeA / 1 MiniB
Video In *1		-	-	-
Audio In/Out *2				
Remote Control / Monitor			✓	✓
Approvals		IP65, Type 13,UL508, UL1604, CSA C22.2 No.213	IP66F, UL508, CSA C22.2 NO 142.213 ANSI/ISA:12.12.01 Type 4x and 13 Class I Div 2	IP66F,UL508, CSA C22.2 No.142/213, ANSI/ISA:12.12.01 Type 4x and 13 Class I Div 2
Bezel	Light Gray	HG1F-SB22BF-W	HG2G-5TN22TF-W HG2G-5TN22TF-B HG2G-5TN22TF-S	HG2G-5TT22TF-W HG2G-5TT22TF-B HG2G-5TT22TF-S
	Black	HG1F-SB22BF-B		
	Silver	-		

Character Display



Display Type	2-line, 4-line, or 8 line display
Memory Size	24KB or 64KB
Rated Voltage	5VDC or 24VDC
Communication Type	RS-232 or RS-422/RS-485
Number of Screens	Users can easily define as many screens as allowed by the unit's memory
Keys	Keys are user definable
LED	LEDs can provide on/off status for users to provide simple monitoring
Numeric Keypad	4 or 8 line display
Bitmap Capability	8 line display only
Serial Printer	For printing screens and alarms
Support of Most Major PLC Manufacturers	Yes
Safety Standards	UL508
Degree of Protection	IP65

1. HG2G-5ST22VF models (color without ethernet) do not support Power Failure Backup Data

High Performance Series

Key Features:

- 5.7", 8.4", 10.4", and 12.1" sizes
- 65,536 Color TFT LCD
- Mounts Portrait or Landscape
- Video and Audio Interface on select units
- Super Bright: Up to 800 cd/m²
- Supports Expansion Discrete I/O modules
- Remote Access, Monitor and Control
- Serial, Ethernet, and USB ports

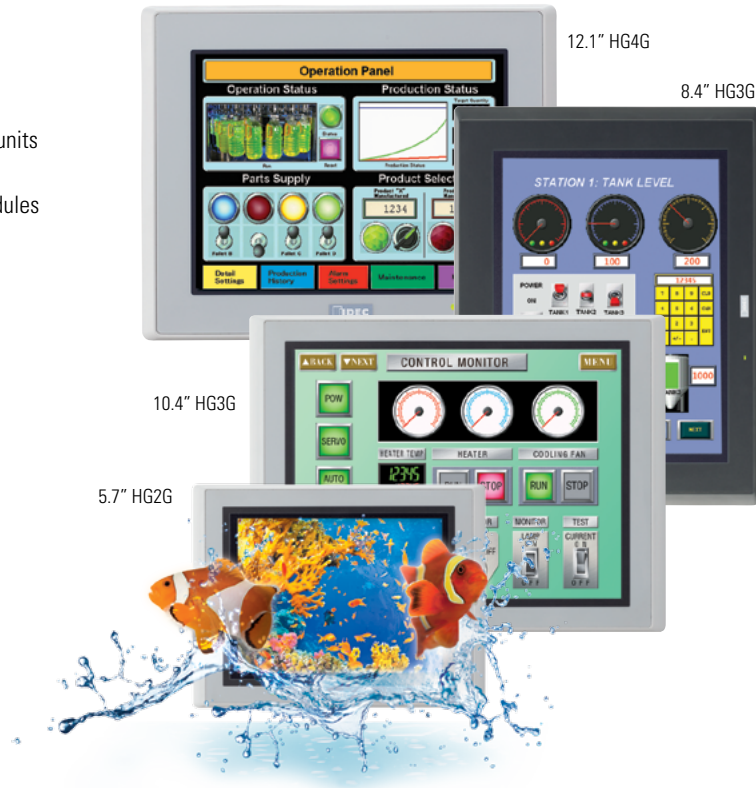

Our high-performance OI Touchscreens are so vivid thanks to cutting-edge color conversion technology, the same technology used in LCD TVs. These screens deliver a superior experience with intense screens.

High-Definition Quality TFT LCD displays

Brightest on the market

With an LED backlight shining up to 800 cd/m², OI Touchscreens create a very powerful visual presentation. Immediately after the touchscreen is turned on, the screen lights up and lasts much longer than a CCFL (Cold Cathode Fluorescent Lamp) with a lifespan of 50,000 hours or greater. A 48-level adjustment also provides flexibility, allowing you to determine the brightness.

SVGA resolution

The High Definition Quality TFT LCD Screens with SVGA resolution (8.4", 10.4" and 12.1" OI Touchscreens) provide sharp images and superior visibility. The high resolution also gives you more space to create additional images and parts for your project, while enjoying exceptional clarity.

65,536 Colors

With so many colors, screen views are realistic and crisp, providing true-to-life images and making it easy to view precise readings of data and images. Distinctly different from 8-bit, 256 color screens, the high-performance series offers an intense depth-of-color perfect for graphical displays.



Real-time video monitoring

Play movie files and audio right on your touchscreen

The high-performance series (8.4", 10.4" and 12.1" OI Touchscreens) feature a built-in video interface (Video In) and audio interface (Audio In/Out). That means a video camera, microphone and speaker can be connected to the OI Touchscreen and used in the following ways:

- Display video images on the touchscreen display
- Play movie files on the touchscreen display (MP4 supported)
- Play audio files on the touchscreen display
- Video recording function

Using the video and audio interfaces, you can monitor machine conditions on the plant floor simply by using a video camera and microphone and setting it to display on the OI Touchscreen. You can also play your operation manual as a movie or play movie files to give information or instructions to a user or customer. This makes it easy to explain detailed information and makes it a useful feature when you are troubleshooting.



Remote access, monitoring and control

Connect anytime, anywhere using your PC, PDA or Smart Phone

Distance isn't an issue with our high-performance line of OI Touchscreens. When you need access to your machine or equipment, but can't get to the factory floor or even to the office, all you need is a computer, PDA or Smartphone and you can remotely access, monitor and control your touchscreen through a web browser. It's that simple!

Monitor current values or processes, click pushbuttons to control operation, print, switch screens or even change program values just as if you were in front of your touchscreen on site. You can also troubleshoot, test and do maintenance.

- No additional software tools or modules needed to use the Remote Monitor and Control function
- Up to 5 clients can remotely monitor and control simultaneously
- Simple configuration to enable remote access

Expand your control

With a wide range of connectivity options, our high-performance OI Touchscreens offer a communication solution for every application. Store programming or log data with up to 12MB of user memory, communicate with multiple controllers and devices and even remotely monitor and control. If extra storage is needed, an SD card or USB flash drive can easily be used.

SD Card

- Supports up to a 32GB SD card for storage
- Store IEC MicroSmart ladder and touchscreen programs, pictures, log data, alarm logs, screen hard copies, recipe data, operation logs, audio and video files

USB Port A (USB 2.0)

- Connect a USB flash drive
 - Store IEC MicroSmart ladder and touchscreen programs, log data and screen capture (if transferred from SD card)
- Connect barcode readers

USB Port mini B

- Connect PC directly to OI Touchscreen for high speed transfer of program upload, download, or monitoring
- Connect to a USB printer

Ethernet Port

- 10BaseT or 100Base-TX connection
- Remote communication with the PLC and download, upload or monitor PLC and OI Touchscreen projects
- Allows remote access for monitor and control



**The connectivity you want,
the flexibility you need**

Expansion Module

Depending on your application and OI Touchscreen size, up to 4 MicroSmart expansion digital I/O modules can be connected. They easily snap on the back of any High-performance Series OI Touchscreen to offer simple I/O control with the option to perform independently of the touchscreen scan time using Cyclic Script.

**2 Serial Ports
RS232 and RS485 (422)**

- Host – Communicate with a PLC/device using 1:1 or 1:N PLC communication
- Sub Host – Communicate with an IDEC MicroSmart PLC or Modbus RTU device
- O/I Link – Various PLCs including the IDEC MicroSmart PLC can network with multiple OI Touchscreens, where one is a master and up to 15 slaves are connected
- User – Communicate using transmit or receive instructions to build your own protocol

Audio Out Port:

- Connects to speakers to playback pre-saved .WAV audio files for custom alarms or alerts

Audio In Port

- Connects to a microphone to listen and monitor audio sounds

Video In Port

- Connects to a video camera to display video images on the touchscreen



Fast. Flexible. Environmentally-friendly!

Mounting Flexibility

All High-Performance series can be mounted with the screen orientation set to portrait or landscape mode depending on space requirements. This allows you the flexibility of mounting the touchscreen according to your specific application needs. Plus OI Touchscreens are designed with a slim body style, providing a big advantage in situations where panel space is at a premium.



Portrait



Landscape



Low Energy Consumption

Designed with an energy-saving design and LED backlight, these touchscreens use 50% less energy compared with conventional models. While all OI Touchscreens in the high-performance series consume a maximum of 27 Watts of power (depending on model size), if a USB Host and Expansion I/O are not used, less wattage is used. For instance, the 8.4" and 10.4" consume a maximum of 15 Watts when not using these devices. Similarly, having full control of how and when the LED backlight dims or goes to sleep mode allows you to save more energy.



Approvals

We are dedicated to ensuring the safety of life and property at sea. To that end, IDEC OI Touchscreens are trusted and approved by leading maritime classification agencies, such as the American Bureau of Shipping (ABS Type Approval), Lloyd's Register and NK. This means our touchscreens meet technical and safety needs that allow them to be used in marine, offshore structures and shore-based installations. All high-performance models are also CE-marked and c-UL-us listed.

High-speed CPU

The fastest in its class, a 400MHz RISC processor means that these touchscreens have quick operation and response times, as well as exceptional performance. Not to mention, start-up is 3 seconds from power on, so you can start working without delay.

HG2G-5T Series

5.7" Color LCD OI Touchscreen



5.7" Mono LCD OI Touchscreen



Key Features

- 5.7-inch TFT LCD HMI
- 65K color,
- 16 shade monochrome
- Super-bright display:
 - 500 cd/m² (color)
 - 1100 cd/m² (monochrome)
- Support up to four protocols simultaneously
- Wide range of operating temperatures: -20°C to 60°C
- Backlight Longevity: >100,000 hours
- Remote monitor and control
- Portrait and landscape mounting
- Resistive analog touchscreen
- 2 Serial, 2 USB and Ethernet ports
- Rated Power Voltage: 12 – 24VDC
- IP 66F, Type 4X, Class I Div 2

4.6" Monochrome LCD OI Touchscreen



Key Features

- 16 level Monochrome
- Available in RS232 or RS422/RS485 version
- Super bright LCD screen with 500 cd/m²
- Analog resistive touch panel enables flexible screen layout
- High resolution: 300x100 pixels
- Screen orientation: landscape or portrait
- Large memory capacity of 1MB

Over 100 Serial and Networking Drivers are Supported

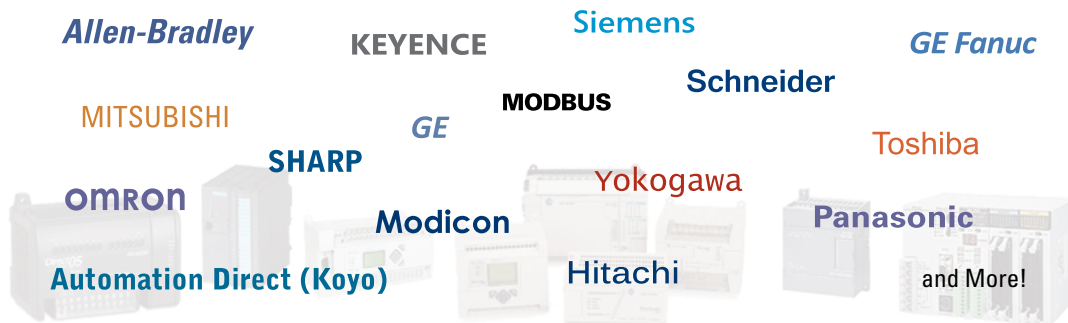

Visit www.IDEC.com/oi/drivers for a list of all drivers!

Automation Organizer Suite

Programming Software

Part Number

SW1A-W1C	Automation Organizer Software Suite
----------	-------------------------------------



Automation Organizer (AO), the IDEC software suite combining the latest versions of our popular PLC programming software (WindLDR) and OI programming software (WindO/I-NV2) and (WindO/I-NV4) with new system configuration software (WindCFG) , is made to enable you to see the layout of your system design and basic configuration of devices. AO gives you a powerful and easy-to-use tool to design, debug, and document control systems, saving valuable time and money.

Intuitively working with you, WindO/I-NV2 and WindO/I-NV4 walks you through an easy step-by-step configuration of your images and your workspace. Dragging and dropping makes screen creation fast, even for beginners. Plus debugging, previewing and editing can be handled through the easy-to-use graphic user interface. Designed with a modern look and feel, similar to MS Office 2007 style, a customizable toolbar and workspace with drop down menu and ribbon control make it simple to select parts, objects and functions. You can also change the toolbar by adding icons frequently used on your project, saving programming time and allowing you to customize your workspace.

For more information, see page 133.



PLC programming with WindLDR



OI programming with WindO/I-NV2



System Configuration with WindCFG



Programming software for HG2G-5T

Supported Drivers

Manufacturer	Series	Applicable CPU	Communication Module	Comm. Type	Host I/F Driver	Support OI Touchscreens Series			
						12.1" HG4G	8.4" and 10.4" HG3G	5.7" HG2G	4.6" HG1F
IDEC	MicroSmart/ Pentra MicroSmart (FC4A/FC5A)	FC4A, FC5A	Built-in Port or Comm. Module	RS232	OpenNet(FC3A), MicroSmart (FC4A/FC5A)	x	x	x	x
				RS485 (422)		x	x	x	x
			Built-in or Web Server Unit (FC4A-SX5ES1E)	Ethernet	Web Server Unit (FC3A/FC4A/ FC5A)	x	x	x	—
	OpenNet	FC3A	Built-in Port	RS232	OpenNet(FC3A), MicroSmart (FC4A/FC5A)	x	x	x	x
				RS485		x	x	x	x
			Web Server Unit (FC4A-SX5ES1E)	Ethernet	Web Server Unit (FC3A/FC4A/ FC5A)	x	x	x	—
Allen Bradley	MicroLogix	MicroLogix 1000	Built-in Port	RS 232	MicroLogix / SLC 500 Full Duplex	x	x	x	x
			1761-NET-ENI	Ethernet	Ethernet / IP	x	x	x	—
		MicroLogix 1100	Built-in Port	RS 232	MicroLogix / SLC 500 Full Duplex	x	x	x	x
			Built-in or 1761-NET-ENI	Ethernet	Ethernet / IP	x	x	x	—
		MicroLogix 1200	Built-in Port	RS 232	MicroLogix / SLC 500 Full Duplex	x	x	x	x
			1761-NET-ENI	Ethernet	Ethernet / IP	x	x	x	—
	MicroLogix 1500	Built-in Port	RS 232	MicroLogix / SLC 500 Full Duplex	x	x	x	x	
		1761-NET-ENI	Ethernet	Ethernet / IP	x	x	x	—	
	ControlLogix	ControlLogix 5550	RS232	Built-in Port	Logix DF1 (Full Duplex)	x	x	x	x
				Ethernet	Ethernet / IP	x	x	x	—
			Ethernet / IP (Native Tag)	x	x	x ¹	—		
		ControlLogix 5555	RS232	Built-in Port	Logix DF1 (Full Duplex)	x	x	x	x
Ethernet			Ethernet / IP	x	x	x	—		
Ethernet / IP (Native Tag)			x	x	x ¹	—			
CompactLogix	1768 CompactLogix	Built-in Port	RS232	Logix DF1 (Full Duplex)	x	x	x	x	
			Ethernet	Ethernet / IP (Native Tag)	x	x	x ¹	—	
	1769 CompactLogix	Built-in Port	Ethernet	Ethernet / IP	x	x	x	—	
			Logix DF1 (Full Duplex)	x	x	x	x		
FlexLogix	1794-L33	Built-in Port	RS232	Logix DF1 (Full Duplex)	x	x	x	x	
	1794-L34								
PLC-5	PLC-5	1770-KF2	Built-in Port	RS232 or RS485	PLC-5 (Half Duplex)	x	x	x	x
		1785-ENET		Ethernet					
		PLC-5E	Built-in Port	Ethernet	Ethernet / IP	x	x	x	—
SLC 500	SLC 5/03, 5/04, 5/05	Built-in Port	RS 232	SLC 500 Half Duplex or Mi- croLogix / SLC 500 Full Duplex	x	x	x	x	
		1761-NET-ENI	Ethernet	Ethernet / IP	x	x	x	—	

 1. HG2G-5FT only.

Drivers continued on next page.

OI Touchscreens

PLCs

Automation Software

Power Supplies

Sensors

Communication

Barriers

Supported Drivers, con't

Manufacturer	Series	Applicable CPU	Communication Module	Comm. Type	Host I/F Driver	Support OI Touchscreens Series			
						12.1" HG4G	8.4" and 10.4" HG3G	5.7" HG2G	4.6" HG1F
Automation Direct (Koyo)	DirectLOGIC 05	DL05	D0-ECOM, D0-ECOM100	Ethernet	DirectLOGIC (Ethernet)	x	x	x	—
	DirectLOGIC 06	DL06				x	x	x	—
	DirectLOGIC	D2-240, D2-250, D2-250-1, D2-260	D2-ECOM, D2-ECOM-F, D2-ECOM100			x	x	x	—
	DirectLogic DL205	D2-240	Built-in Port	RS232	DirectLogic DL 205/405	x	x	x	x
	DirectLogic DL405	D4-430, D4-440	Built-in Port	RS232 RS485(422)		x	x	x	x
		D4-440	D4-DCM	RS232		x	x	x	x
		D4-430, D4-440, D4-450	D4-ECOM, D4-ECOM-F, D4-ECOM100	Ethernet	DirectLOGIC (Ethernet)	x	x	x	—
Emerson	Fisher Roc Driver	FloBoss	FloBoss 107	Built-in	RS232, RS485	x	x	x	—
FANUC	Power Mate	Power Mate-MODEL D	Built-in Port	RS422	Power Mate-MODEL D/Series 16i	x	x	x	x
	Series	16i, 160i, 18i, 180i, 30i, 31i, 32i	Built-in Port	RS232		x	x	x	x
FUJI	FLEX-PC	NB1, NB2, NB3, NJ-CPU-E4, NJ-CPU-A8, NJ-CPU-B16, NS	Built-in Port	RS232, RS485	FLEX-PC (CPU)	x	x	x	x
		NB1, NB2, NB3	NB-RS1-AC/DC	RS232, RS485	FLEX-PC(LINK)	x	x	x	x
		NJ-CPU-E4, NJ-CPU-A8, NJ-CPU-B16	NJ-RS2, NJ-RS4	RS232, RS485		x	x	x	x
		NS	NS-RS1	RS232, RS485		x	x	x	x
MICREX-F	MICREX-F	FS5	NV1L-RS2	RS232	MICREX-F	x	x	x	x
		F70	NC1L-RS2	RS232		x	x	x	x
			NC1L-RS4	RS485		x	x	x	x
		F80H, F120H, F120S, F140S, F150S	FFU120B	RS232	x	x	x	x	
		F30, F50, F50H, F55, F60, F70, F70S, F80H, F81, F120H, F120S, F140S, F150S, F250	FFK120A-C10	RS232, RS485		x	x	x	x
GE Fanuc Automation	Series 90-30	CPU331, CPU341, CPU350, CPU351, CPU352, CPU360, CPU363, CPU364, CPU374	IC693CMM311	RS232	Series 90 (XNP-X)	x	x	x	x
				RS485(422)		x	x	x	x
	CPU311, CPU313, CPU323, CPU331, CPU341, CPU350, CPU351, CPU352, CPU360, CPU363, CPU374	Built-in Port	RS485(422)	x		x	x	x	
	VersaMax	Nano, Micro (14point), Micro (23, 28 point)	Built-in Port	RS232		x	x	x	x
RS485				x	x	x	x		

Drivers continued on next page.

Supported Drivers, con't

Manufacturer	Series	Applicable CPU	Communication Module	Comm. Type	Host I/F Driver	Support OI Touchscreens Series			
						12.1" HG4G	8.4" and 10.4" HG3G	5.7" HG2G	4.6" HG1F
Hitachi	S10mini	S10mini	Built-in Port	RS485(422)	S10mini	x	x	x	x
			LQE160, LQE560	RS232		x	x	x	x
			LQE165, LQE565	RS485(422)		x	x	x	x
	S10V	LQP510	Built-in Port	RS232, RS485		x	x	x	x
			LQE560	RS232		x	x	x	x
			LQE565	RS485(422)		x	x	x	x
INVERTER	FREQROL	FREQROL-E500, FREQROL-S500	Built-in Port	RS485(422)	FREQROL	x	x	x	x
JTEKT (Toyota)	TOYOPUC-PC2J	PC2J	Built-in Port	RS485(422)	TOYOPUC-PC3J	x	x	x	x
	TOYOPUC-PC3J	PC3J, PC3JD, PC3JG				x	x	x	x
Keyence	KV-700/1000/3000/5000	KV-700, KV-1000, KV-3000	Built-in Port	RS232	KV-700/1000	x	x	x	x
			KV-L-20R	RS232 (Port 1,2), RS422/485		x	x	x	x
		KV-700, KV-1000, KV-3000, KV-5000	KV-LE20A, KV-LE20V	Ethernet	KV (Ethernet)	x	x	x	-
			KV-5000	Built-in Port		x	x	x	-
	Visual KV	KV-10, 16, 24, 40	Built-in Port	RS232	KV/KZ	x	x	x	x
	Conventional KV	KV-10, 16, 24, 40/80				x	x	x	x
LS Industrial Systems	MASTER-K	K10S1, K80S, K120S, K200S	Built-in Port	RS232	MASTER-K	x	x	x	x
		K80S	G7L-CUEB, G7L-CUEC			x	x	x	x
		K200S	G6L-CUEB, G6L-CUEC			x	x	x	x
		K300S	G4L-CUEA			x	x	x	x
Mitsubishi	MELSEC-A	A1N, A2N, A3N	AJ71C24-S3/S6/S8 or AJ71UC24	RS232	MELSEC-AnN (LINK)	x	x	x	x
		A1SH	A1SJ71C24-R2/R4 or A1S-J71UC24-R2/R4	RS232		x	x	x	x
		A2CCPUC24	Built-in-Port	RS232		x	x	x	x
		A0J2, A0J2H	A0J2-C214-S1	RS232		x	x	x	x
				RS485		x	x	x	x
		A2A, A3A, A2U, A3U, A4U	AJ71C24-S6/-8, AJ71UC24	RS232		x	x	x	x
				RS485		x	x	x	x
		A2US, A2USH-S1	A1SJ71C24-R2, A1SJ71UC24-R2	RS232		x	x	x	x
				RS485		x	x	x	x
		A2N, , A2A, A3A, A2US, A2USH, A2U, A2USH-S1	Built-in Port	RS485(422)		MELSEC-AnA (CPU)	x	x	x
MELSEC-A1S/A2C(CPU)	x				x	x	x		
		A1SH, A2SH, A2C, A0J2H							

Drivers continued on next page.

OI Touchscreens

PLCs

Automation Software

Power Supplies

Sensors

Communication

Barriers

Supported Drivers, con't

Manufacturer	Series	Applicable CPU	Communication Module	Comm. Type	Host I/F Driver	Support OI Touchscreens Series				
						12.1" HG4G	8.4" and 10.4" HG3G	5.7" HG2G	4.6" HG1F	
Mitsubishi	MELSEC-QnA	Q4ACPU, Q4AR-CPU, Q3ACPU-S1, Q2ACPU	AJ71QC24N-R2, AJ71QC24N,	RS232	MELSEC-Q/QnA (LINK)	x	x	x	x	
			AJ71QC24N-R4	RS485		x	x	x	x	
				Ethernet		MELSEC-Q/QnA (Ethernet)	x	x	x	—
			MELSEC-QnA	Q2ASHCPU-S1, Q2ASHCPU, Q2ASCPU-S1, Q2ASCPU	A1SJ71QC24N-R2	RS232	MELSEC-Q/QnA (LINK)	x	x	x
	A1SJ7AQC24N	RS485			x	x		x	x	
		Ethernet			MELSEC-Q/QnA (Ethernet)	x		x	x	—
	MELSEC-Q	Q00CPU, Q01CPU			Built-in Port	RS232	MELSEC-Q/QnA (LINK)	x	x	x
			RS485	x		x		x	x	
			QJ71C24N-R2	RS232	x	x		x	x	
				RS485	x	x		x	x	
		Q02CPU, Q02HCPU	Built-in Port	RS232	MELSEC-Q (CPU)	x	x	x	x	
				RS485	MELSEC-AnU(CPU)	—	—	—	x	
		Q00JCPU, Q00CPU, Q01CPU	QJ71E71-100, QJ71E71-B5, QJ71E71-B2	Ethernet	Ethernet	MELSEC-Q/QnA (Ethernet)	x	x	x	—
						x	x	x	—	
	MELSEC-FX	FX1, FX2, FX2C	Built-in Port	RS485(422)	MELSEC-FX (CPU)	x	x	x	x	
						x	x	x	x	
		FX2N, FX2NC, FX1N, FX1NC	FX2NC-232ADP	RS232	MELSEC-FX2N (CPU)	x	x	x	x	
				RS232		x	x	x	x	
		FX2N	FX2N-232-BD	RS232		x	x	x	x	
			FX2N-422-BD	RS485(422)		x	x	x	x	
		FX1N	FX1N-232-BD	RS232	x	x	x	x		
			FX1N-422-BD	RS485(422)	x	x	x	x		
		FX3UC, FX3U	Built-in Port	RS485(422)	MELSEC-FX3UC(CPU)	x	x	x	x	
				RS232		x	x	x	x	
FX3G	Built-in Port	RS485(422)	x	x		x	x			
		RS232	x	x		x	x			

Drivers continued on next page.

OI Touchscreens

PLCs

Automation Software

Power Supplies

Sensors

Communication

Barriers

Supported Drivers, con't

Manufacturer	Series	Applicable CPU	Communication Module	Comm. Type	Host I/F Driver	Support OI Touchscreens Series					
						12.1" HG4G	8.4" and 10.4" HG3G	5.7" HG2G	4.6" HG1F		
Omron	SYSMAC-C	C500, C500F, C1000H, C2000, C2000H	C120-LK201-V1	RS232	SYSMAC-C Series	x	x	x	x		
			C120-LK202-V1	RS485(422)		x	x	x	x		
			C500-LK201-V1	RS232		x	x	x	x		
				RS485(422)		x	x	x	x		
			C500-LK203	RS232		x	x	x	x		
				RS485(422)		x	x	x	x		
		C1000HF	C500-LK203	RS232		x	x	x	x		
				RS485(422)		x	x	x	x		
		C200HS	C200H-LK201	RS232		x	x	x	x		
			C200H-LK202	RS485(422)		x	x	x	x		
		C200HE, C200HG, C200HX	C200H-LK201, C200HW-COM02/COM04/COM05/COM06	RS232		x	x	x	x		
			C200H-LK202, C200HW-COM03/COM06	RS485(422)		x	x	x	x		
		C120, C120F	C120-LK201-V1	RS232		x	x	x	x		
				RS485(422)		x	x	x	x		
		C20H, C28H, C40H, C60H	Built-in Port	RS232		x	x	x	x		
		CQM1H, C200HS-CPU21/23/31/33				x	x	x	x		
		C200HE-CPU42, C200HG-CPU43/63, C200HX-CPU44/64	Built-in Port	RS232		x	x	x	x		
		CPM1, CPM1A, CPM2A				CPM1-CIF01	x	x	x	x	
		CMP2A	Built-in Port	RS232		CPM1-C1F11	RS485(422)	x	x	x	x
						Built-in Port	RS232	x	x	x	x
		SYSMAC-CS1	CS1G, CS1H	Built-in Port		RS232	SYSMAC-CS1 Series	x	x	x	x
				CS1W-SCB41 (Port1)				x	x	x	x
				CS1W-SCB41 (Port2)		RS485(422)		x	x	x	x
				CS1W-ENT01, CS1W-ENT11, CS1W-ENT21, CJ1W-ENT21		Ethernet		SYSMAC-CS1 CJ Series (Ethernet)	x	x	x
SYSMAC-CJ1	CJ1M, CJ1H, CJ1G	Built-in Port	RS232	SYSMAC-CS1 Series	x	x	x	x			
		CS1W-ENT01, CS1W-ENT11, CS1W-ENT21, CJ1W-ENT21	Ethernet	SYSMAC-CS1 CJ Series (Ethernet)	x	x	x	-			
SYSMAC-CJ2	CJ2H	Built-in Port			x	x	x	-			
SYSMAC-CP1	CP1H	CP1W-CIF01	RS232	SYSMAC-CS1 Series	x	x	x	x			
		CP1W-CIF11	RS485(422)		x	x	x	x			

Drivers continued on next page.

OI Touchscreens

PLCs

Automation Software

Power Supplies

Sensors

Communication

Barriers

Supported Drivers, con't

Manufacturer	Series	Applicable CPU	Communication Module	Comm. Type	Host I/F Driver	Support OI Touchscreens Series						
						12.1" HG4G	8.4" and 10.4" HG3G	5.7" HG2G	4.6" HG1F			
Panasonic (Aromat)	FP Series	FP0, FP1	Built-in Port	RS232	MEWNET	x	x	x	x			
			Built-in Port			x	x	x	x			
		FP(SIGMA symbol)	AFPG801	RS232		x	x	x	x			
			AFPG802			x	x	x	x			
			AFPG803	RS485		x	x	x	x			
		FP10, FP10SH	Built-in Port	RS232		x	x	x	x			
			AFP3462			x	x	x	x			
			Built-in Port			x	x	x	x			
			AFP2462			x	x	x	x			
		Sharp	New Satellite JW	JW-10		Built-in Port	RS422-MMI Port, RS485	JW	x	x	x	x
				JW-21CPU, JW-22CU, JW-31CUH/H1, JW-32CUH/H1, JW-33CUH1/H2/3		JW-21CM	RS485(422)		x	x	x	x
				JW-50CU/CUH					x	x	x	x
JW-70CU/CUH	JW-10CM				x	x	x		x			
JW-100CU/CUH					x	x	x		x			
JW-22CU, JW-70CU/CUH, JW-100CU/CUH	Built-in Port			RS232	x	x	x		x			
JW-32CUH/H1, JW-33CUH/H1/H2/H3				RS485(422)	x	x	x		x			
SIEMENS	S7-200	CPU212, CPU214, CPU215, CPU216, CPU221, CPU222, CPU224, CPU224XP, CPU226, CPU226XM	Built-in Port	RS485(422)	S7-200 (PPI)	x	x	x	x			
		CPU313, CPU314, CPU315, CPU315-2DP, CPU316, CPU318	CP-340, CP-341	RS232 RS485(422)	S7-300 3964(R)/RK512	x	x	x	x			
	S7-300	CPU313-2PtP	Built-in Port	RS485(422)	S7-MP1	x	x	x	x			
		CPU412, CPU414, CPU416, CPU416F-2, CPU417	CP-440, CP-441	RS232, RS485(422)	S7-300 3964(R)/RK512	x	x	x	x			

Drivers continued on next page.

Communication

Barriers

PLCs

Automation Software

Power Supplies

Sensors

OI Touchscreens

Supported Drivers, con't

Manufacturer	Series	Applicable CPU	Communication Module	Comm. Type	Host I/F Driver	Support OI Touchscreens Series			
						12.1" HG4G	8.4" and 10.4" HG3G	5.7" HG2G	4.6" HG1F
Toshiba	PROSEC T	T1 (T1-16, T1-28, T1-40)	Built-in Port	RS232,	PROSEC T	x	x	x	x
			CU111	RS485(422)		x	x	x	x
		T1S (T1-40S)	Built-in Port	RS232,		x	x	x	x
			CU111	RS485(422)		x	x	x	x
		T2 (PU224)	Built-in Port	RS485		x	x	x	x
		T2E (PU234E)	CM231E	RS485		x	x	x	x
			CM232E	RS232		x	x	x	x
	T2N (PU215N, PU235N, PU245N)	Built-in Port	RS232	x		x	x	x	
			RS485	x		x	x	x	
			T3, T3H (PU315, PU325, PU325H, PU326H)	Built-in Port		RS485	x	x	x
	V Series	S2T, S2E, L1, S2, S3 (PU672T, PU662T, PU612E, L1PU11H, L1PU12H, S2PU82, S2PU72, S2PU32, S2PU22, S3PU65, S3PU55, S3PU45, S3PU21)	Built-in Port	RS485	x	x	x	x	
Toshiba Machine Works	TC200	TC3-13B1	Built-in Port	RS232	TC200	x	x	x	x
	TCmini	TC03-01, TC03-02		RS485	x	x	x	x	
VIGOR	VB or VH	VB: V0, VB1, VB2 or VH: VH	Built-in Port	RS232	VB/VH	x	x	x	x
			VB-485A	RS485		x	x	x	x
			VB-CADP	RS232		x	x	x	x
				RS485		x	x	x	x
			VB-232	RS232		x	x	x	x
			VB-485	RS485		x	x	x	x
YASKAWA	Machine Controller	MP920, MP930	Built-in Port	RS232,	MP920_R	x	x	x	x
			217IF	RS422, RS485		x	x	x	x
		MP2300	217IF-01	RS232, RS422, RS485		x	x	x	x
YOKOGAWA	FA-M3	FA-M3 (F3SP05, F3SP20, F3SP21, F3SP25, F3SP30, F3SP35, F3SP38, F3SP53, F3SP58, F3FP36, F3BP20, F3BP30)	F3LC11-1N	RS232	FA-M3	x	x	x	x
			F3LC11-2N	RS485		x	x	x	x
		FA-M3 (F3SP05, F3SP21, F3SP25, F3SP28, F3SP35, F3SP38, F3SP53, F3SP58)	Built-in Port	RS232		x	x	x	x

OI Touchscreens

PLCs

Automation Software

Power Supplies

Sensors

Communication

Barriers

Part Numbers

Style	Part Numbers	Bezel Color	Description		
High Performance Series		HG4G-CJT22MF-B	Black	12.1" 65K Color TFT, Video In, Audio In/Out	
		HG3G-AJT22MF-W	Light Gray		
		HG3G-AJT22MF-B	Black	10.4" 65K Color TFT, Video In, Audio In/Out	
		HG3G-8JT22MF-W	Light Gray		
		HG3G-8JT22MF-B	Black	8.4" 65K Color TFT, Video In, Audio In/Out	
		HG2G-5FT22TF-W	Light Gray		
	HG2G-5T Series		HG2G-5FT22TF-B	Black	5.7" 65K Color TFT
			HG2G-5FT22TF-S	Silver	
			HG2G-5TT22TF-W	Light Gray	
			HG2G-5TT22TF-B	Black	5.7" 65K Color TFT, Ethernet Port, 12-24V DC
			HG2G-5TT22TF-S	Silver	
			HG2G-5TN22TF-W	Light Gray	
	HG2G-5TN22TF-B	Black	5.7" Monochrome, TFT, Ethernet Port, 12-24V DC		
	HG2G-5TN22TF-S	Silver			
		HG1F-SB22BF-W		Light Gray	4.6" Monochrome, RS232 Type
		HG1F-SB22BF-B		Black	
HG1F-SB22YF-W		Light Gray	4.6" Monochrome, RS-485 / RS-422 Type		
HG1F-SB22YF-B		Black			

Starter Kits and Solution Packages
Touchscreen Starter Kits





Operator Interface			Power Supply	Software and Cable	Part Number	
HG2G-5T Series		4.6" Monochrome, RS232	HG1F-SB22BF-B	30W	√	SMARTTOUCH-1F
		5.7" 65K Color TFT, 12-24V DC	HG2G-5TT22TF-B	30W	√	SMARTTOUCH-2G-5TT
		5.7" Monochrome TFT, 12-24V DC	HG2G-5TN22TF-B	30W	√	SMARTTOUCH-2G-5TN
High-Performance Series		5.7 65K Color TFT, Ethernet	HG2G-5FT22TF-B	60W	√	SMARTTOUCH-2GHP
		8.4" 65K Color TFT , Video In, Audio In/Out	HG3G-8JT22MF-B	60W	√	SMARTTOUCH-3G8HP
		10.4" 65K Color TFT, Video In, Audio In/Out	HG3G-AJT22MF-B	60W	√	SMARTTOUCH-3GAHP
		12.1" 65K Color TFT, Video In, Audio In/Out	HG4G-CJT22MF-B	60W	√	SMARTTOUCH-4GHP

All packages come with Automation Organizer software suite and a communication cable.

Automation Solution Packages



KIT-PENTRA-12-HG3G-AHP shown

Operator Interface Touchscreen	CPU	Power Supply	Part Number	
	4.6" Monochrome, RS232, HG1F-SB22BF-B	24 I/O, FC5A-C24R2C CPU	60W	KIT-PENTRA-24-HG1F
	4.6" Monochrome, RS232, HG1F-SB22BF-B	12 I/O, FC5A-D12S1E, Ethernet CPU	60W	KIT-PENTRA-12-HG1F
	5.7" Monochrome, 12 to 24V DC, Ethernet, HG2G-5TN22TF-B	24 I/O, FC5A-C24R2C CPU	60W	KIT-PENTRA-24-HG2G-5TN
	5.7" Monochrome, 12 to 24V DC, Ethernet, HG2G-5TN22TF-B	12 I/O, FC5A-D12S1E, Ethernet CPU	60W	KIT-PENTRA-12-HG2G-5TN
	5.7" 65K Color TFT, Ethernet, HG2G-5TT22TF-B	24 I/O, FC5A-C24R2C CPU	60W	KIT-PENTRA-24-HG2G-5TT
	5.7" 65K Color TFT, Ethernet, HG2G-5TT22TF-B	12 I/O, FC5A-D12S1E, Ethernet CPU	60W	KIT-PENTRA-12-HG2G-5TT
	5.7" 65K Color TFT, Ethernet, HG2G-5FT22TF-B	16 I/O, FC5A-D16RS1 CPU	60W	KIT-PENTRA-16-HG2G-HP
	5.7" 65K Color TFT, Ethernet, HG2G-5FT22TF-B	24 I/O, FC5A-C24R2C CPU	60W	KIT-PENTRA-24-HG2G-HP
	5.7" 65K Color TFT, Ethernet, HG2G-5FT22TF-B	12 I/O, FC5A-D12S1E, Ethernet CPU	60W	KIT-PENTRA-12-HG2G-HP
	8.4" 65K Color TFT, Video In, Audio In/Out, HG3G-8JT22MF-B	16 I/O, FC5A-D16RS CPU	60W	KIT-PENTRA-16-HG3G-8HP
	8.4" 65K Color TFT, Video In, Audio In/Out, HG3G-8JT22MF-B	12 I/O, FC5A-D12S1E, Ethernet CPU	60W	KIT-PENTRA-12-HG3G-8HP
	10.4" 65K Color TFT, Video In, Audio In/Out, HG3G-AJT22MF-B	16 I/O, FC5A-D16RS1 CPU	60W	KIT-PENTRA-16-HG3G-AHP
	10.4" 65K Color TFT, Video In, Audio In/Out, HG3G-AJT22MF-B	12 I/O, FC5A-D12S1E, Ethernet CPU	60W	KIT-PENTRA-12-HG3G-AHP
	12.1" 65K Color TFT, Video In, Audio In/Out, HG4G-CJT22MF-B	16 I/O, FC5A-D16RS1 CPU	60W	KIT-PENTRA-16-HG4G-HP
	12.1" 65K Color TFT, Video In, Audio In/Out, HG4G-CJT22MF-B	12 I/O, FC5A-D12S1E, Ethernet CPU	60W	KIT-PENTRA-12-HG4G-HP

OI Touchscreens have black bezels. All packages come with Automation Organizer software suite and communication cables.

OI Touchscreens

PLCs

Automation Software

Power Supplies

Sensors

Communication

Barriers

Accessories

Item	Part Number	Description	Applicable Models					
			12.1"	8.4" and 10.4"	5.7"			4.6"
			HG4G-CJT22MF	HG3G-8JT/AJT	HG2G-5FT	HG2G-5TT	HG2G-5TN	HG1F
Programming Tools	SW1A-W1C	Automation Organizer (includes WiindLDR, Win-dOI-NV2, and WindCFG Programming Software)	✓	✓	✓	✓	✓	✓
	HG9Z-XCM2A	USB Programming Cable USB-miniB (2m)	✓	✓	✓	✓	–	–
	HG9Z-XCM1A	Cable connecting PC to Touchscreen via RS-232 Serial Port	–	–	–	–	✓	✓
	FC4A-USB	USB to RS-232 Converter for PCs without Serial Ports	–	–	–	–	✓	✓
Mounting Clips	SLD-K02	Replacement clips (4 pcs are supplied with HMI)	–	–	✓	✓	✓	✓
	HG9Z-4K2PN04	Replacement clips (4 pcs are supplied with HMI)	✓	✓	–	–	–	–
Host Communication Plug	HG9Z-XT09V	Replacement terminal block plug. (1 is supplied with HMI)	–	–	✓	✓	–	–
	HG9Z-XT09	Replacement terminal block plug. (1 is supplied with HMI)	✓	✓	–	–	✓	–
Replacement Battery	HG9Z-XR1	Lithium battery CR2032 (one battery is supplied with HMI)	✓	✓	✓	✓	✓	✓
USB Cable Lock Pin	HG9Z-XU1	Used to lock USB cable (for USB2)	✓	✓	✓	–	–	–
USB panel-mount extension cable	HG9Z-XCE11	For USB-A port (1m)	✓	✓	✓	–	–	–
	HG9Z-XCE21	For USB-mini B PORT (1m)	✓	✓	✓	✓	–	–
Memory Card	HG9Z-XMS2	SD Memory Card (2GB)	✓	✓	✓	–	–	–
Protective Cover	HG9Z-2E2	Use with 5.7" HMI. Covers entire front of HMI. (min. 3 pcs.)	–	–	✓	✓	✓	–
Protective Sheet ¹	HG9Z-2D5	Use with 5.7" HMI. Sheet lays over LCD area. (min. 5 pcs.)	–	–	✓	✓	✓	–
	HG9Z-3D8	Use with 8.4" HMI. Sheet lays over LCD area. (min. 2pcs.)	–	✓	–	–	–	–
	HG9Z-3DA2	Use with 10.4" HMI. Sheet lays over LCD area. (min. 2pcs.)	–	✓	–	–	–	–
	HG9Z-4DC	Use with 12.1" HMI. Sheet lays over LCD area. (min. 2pcs.)	✓	–	–	–	–	–
Expansion Module Clamp ²	HG9Z-1D	Use with 4.6" HMI. Sheet lays over LCD area (min.5 pcs)	–	–	–	–	–	✓
	HG9Z-XJ3	Short type for installing expansion I/O modules (Total width 17.6 to 41.1mm)	✓	✓	✓	–	–	–
	HG9Z-XJ4	Long type for installing expansion I/O modules (Total width 47 to 68.8 mm)	✓	✓	✓	–	–	–
L-shaped Terminal Block Connector for I/O Module	HG9Z-XJ5	Extra-Long type for installing expansion I/O modules (Total width 70.1 to 93.9 mm)	✓	✓	✓	–	–	–
	HG9Z-PMT10L	For 10 pole MicroSmart I/O Module (min. 2 pcs)	✓	✓	✓	–	–	–
	HG9Z-PMT11L	For 11 pole MicroSmart I/O Module (min. 2 pcs)	✓	✓	✓	–	–	–
Replacement Backlight	HG9Z-1FB	Replacement backlight for 4.6" HG1F	–	–	–	–	–	✓
O/I Link Unit	HG9Z-2G1	Communication module for O/I Link mode	–	–	–	✓	✓	✓
Panel Mount Adaptor	HG9Z-2A1	Adaptor for mounting HG2G to the panel cut-out of HG2F	–	–	✓	✓	✓	–
	HG9Z-2A2	Adaptor for mounting HG2G to 156 x 123.5 mm panel cut-out (other mfr.)	–	–	✓	✓	✓	–

Accessories continued next page.

Accessories, con't

Item	Part Number	Description	Applicable Models					
			12.1"	8.4" and 10.4"	5.7"			4.6"
			HG4G-CJT22MF	HG3G-8JT/AJT	HG2G-5FT	HG2G-5TT	HG2G-5TN	HG1F
Converters	HG9Z-GWDF1DH485-4	AB SLC500 (w/RJ45 connector)DF1 / DH485 Communication Pakg for 4.6" HG1F	-	-	-	-	-	✓
	HG9Z-GWDF1DH485-5	AB SLC500 (w/RJ45 connector)DF1 / DH485 Communication Pakg for HG2G/HG3G/HG4G	✓	✓	✓	✓	✓	-

- 1. The protective sheet is UV resistant, however, resistance against direct sunlight in outdoor usage is not guaranteed.
- 2. Use the expansion module clamp when using expansion modules.
Order the module clamp by referring to the width of the module shown in the dimensions of each module.
Note: When connecting more than 3 expansion modules to the HG3G/4G, note the limits shown below:
-Current flow rate at 5V: 130 mA max. Total width: 92.3 mm max.
-Current flow rate at 24V: 150 mA max.

Expansion Modules (Applicable for 12.1" HG4G, 8.4" and 10.4" HG3G, and 5.7" HG2G-5FT22TF)

	Input Type	Part No. (Ordering No.)	Connector	Dimensions (L x W x H mm)	Consumption Current (mA)	
					5V	24V
					Input Modules	8 points/AC Input
8 points/DC Input	FC4A-N08B1	90.0 x 23.5 x 70.0	25	0		
16 points/DC Input	FC4A-N16B1	90.0 x 23.5 x 70.0	40	0		
16 points/DC Input	FC4A-N16B3	MIL Connector	90.0 x 17.6 x 70.0	35		0
32 points/DC Input	FC4A-N32B3		90.0 x 29.7 x 70.0	65		0
Output Modules	8 points/Relay Output	FC4A-R081	Removable Terminal Block	90.0 x 23.5 x 70.0	30	40
	16 points/Relay Output	FC4A-R161		90.0 x 23.5 x 70.0	45	75
	8 points/Transistor Sink Output	FC4A-T08K1		90.0 x 23.5 x 70.0	10	20
	8 points/Transistor Source Output	FC4A-T08S1	MIL Connector	90.0 x 23.5 x 70.0	10	20
	16 points/Transistor Sink Output	FC4A-T16K3		90.0 x 17.6 x 70.0	10	40
	16 points/Transistor Source Output	FC4A-T16S3		90.0 x 17.6 x 70.0	10	40
	32 points/Transistor Sink Output	FC4A-T32K3		90.0 x 29.7 x 70.0	20	70
32 points/Transistor Source Output	FC4A-T32S3	90.0 x 29.7 x 70.0	20	70		
Mixed I/O Modules	4 points/DC Input 4 points/Relay Output	FC4A-M08BR1	Removable Terminal Block	90.0 x 23.5 x 70.0	25	20
	16 points/DC Input 8 points/Relay Output	FC4A-M24BR2	Non-removable Terminal Block	90.0 x 39.1 x 70.0	65	45

- 1. Use the expansion module bracket when using expansion modules.
- 2. Order the module bracket (S), (L) or (XL) by referring to the width of the module shown in the dimensions of each module.
- 3. When connecting more than 3 expansion modules to HG3G/4G, note the limits shown below:
Limits
Current flow rate at 5V: 130 mA max.
Total width: 92.3mm max.
Current flow rate at 24V: 150 mA max.
- 4. See instruction manual for details on MicroSmart expansion modules.

OI Touchscreens

PLCs

Automation Software

Power Supplies

Sensors

Communication

Barriers

Cables

Manufacturer	Series	Applicable CPU	Comm. Type	Communication Module	Part Numbers: Communication Cable between PLC and OI Touchscreen				
					4.6" HG1F	5.7" (HG2G-5TT, HG2G-5FT), 8.4" and 10.4" (HG3G-8JT/-AJT), 12.1" (HG4G-CJT22MF)	5.7" (HG2G-5FT), 8.4" and 10.4" (HG3G-8JT/-AJT), 12.1" (HG4G-CJT22MF)		
						Terminal Block Type	9 Pin D-sub Type		
IDEC	MicroSmart/ Pentra MicroSmart (FC4A/FC5A)	FC4A, FC5A	RS232	Built-in Port	FC4A-KC1CA	HG9Z-AC102	HG9Z-AC501		
				FC4A-PC1/HPC1	HG9Z-XC183 or FC4A-KC1CA	HG9Z-AC102	HG9Z-AC501		
				FC5A-SIF2	N/A	HG9Z-AC312	N/A		
			RS485	FC4A-PC2/HPC2	HG9Z-1C12A	HG9Z-AC172	N/A		
				FC4A-PC3/HPC3	HG9Z-1C131A	Use Shielded Pair	HG9Z-AC502		
				FC5A-SIF4	N/A	Use Shielded Pair	HG9Z-AC502		
			Ethernet	FC4A-SX5ES1E	N/A	Use CAT 5 Ethernet cable	CAT 5 Ethernet Crossover cable		
				Built-in	Not Supported	CAT 5 Ethernet Crossover cable	CAT 5 Ethernet Crossover cable		
			OpenNet	FC3A	RS232	Built-in Port	HG9Z-XC183	HG9Z-AC162	HG9Z-AC501
					RS485	Built-in Port	HG9Z-1C131A	Use Shielded Pair	HG9Z-AC502
SLC 500	SLC-5/03, SLC-5/04, SLC-5/05	RS232	Built-in Port	HG9Z-XC100	HG9Z-AC112	HG9Z-AC504			
		DH485	Built-in Port	HG9Z-GWDF1DH485-4	HG9Z-GWDF1DH485-5	N/A			
		Ethernet	Built-in(SLC-5/05), 1761-NET-ENI	N/A	CAT 5 Ethernet Crossover cable	CAT 5 Ethernet Crossover cable			
Allen Bradley	MicroLogix	1000, 1200, 1500	RS232	Built-in Port	HG9Z-XC500	HG9Z-AC122	HG9Z-AC511		
			Ethernet	1761-NET-ENI	Not Supported	CAT 5 Ethernet Crossover cable	CAT 5 Ethernet Crossover cable		
		1500	RS232	Built-in Port (9 Pin Dsub)	N/A	HG9Z-AC132	HG9Z-AC505		
		1100, 1400	RS232	Built-in Port	N/A	HG9Z-AC152	HG9Z-AC518		
		1100	Ethernet	Built-in Port	Not Supported	CAT 5 Ethernet Crossover cable	CAT 5 Ethernet Crossover cable		
		ControlLogix	5550, 5555	RS232	Built-in Port	N/A	HG9Z-AC142	HG9Z-AC503	
	Ethernet			1756-ENBT	Not Supported	CAT 5 Ethernet Crossover cable	CAT 5 Ethernet Crossover cable		
	CompactLogix	1768, 1769	RS232	Built-in Port	N/A	HG9Z-AC142	HG9Z-AC503		
			Ethernet	Built-in Port	N/A	CAT 5 Ethernet Crossover cable	CAT 5 Ethernet Crossover cable		
	FlexLogix	1794-L33, 1794-L34	RS232	Built-in Port	N/A	HG9Z-AC142	HG9Z-AC503		
Automation Direct (Koyo)	Direct Logic 05/06	DL05, DL06	Ethernet	D0-ECOM, D0-ECOM100	Not Supported	CAT 5 Ethernet Crossover cable	CAT 5 Ethernet Crossover cable		
	Direct Logic	D2-240,-250,-250-1,-260	Ethernet	D2-ECOM,-ECOMF,-ECOM100	Not Supported	CAT 5 Ethernet Crossover cable	CAT 5 Ethernet Crossover cable		
	Direct Logic 205	D2-240	RS232	Built-in Port	HG9Z-XC400	N/A	HG9Z-AC508		
	Direct Logic 405	D4-430, D4-440	RS232	Built-in Port	N/A	N/A	HG9Z-AC506		
			RS422	Built-in Port	N/A	N/A	HG9Z-AC507		
		D4-430,-440,450	RS232	D4-DCM	N/A	N/A	HG9Z-AC506		
Ethernet	D4-ECOM,-ECOM-F, ECOM100	Not Supported	CAT 5 Ethernet Crossover cable	CAT 5 Ethernet Crossover cable					
GE Fanuc	Series 90-30	CPU331, 341, 350, 351, 352, 360, 363	RS232	IC693CMM311	N/A	N/A	HG9Z-AC510		
			RS485						

Cables, con't

Description					Part Numbers: Communication Cable between PLC and OI Touchscreen		
Manufacturer	Series	Applicable CPU	Comm. Type	Communication Module	4.6" HG1F	5.7" (HG2G-5TT, HG2G-5FT), 8.4" and 10.4" (HG3G-8JT/-AJT), 12.1" (HG4G-CJT22MF)	5.7" (HG2G-5FT), 8.4" and 10.4" (HG3G-8JT/-AJT), 12.1" (HG4G-CJT22MF)
						Terminal Block Type	9 Pin D-sub Type
Mitsubishi	MELSEC A	A1N, A2N, A3N, AOJ2, AOJ2H, A2A, A3A, A2U, A3U, A4U	RS232	AJ71C24/-S3/-S6/-S8, AJ71UC24, AOJ2-C214-S1, AJY1C24-S6/-S8, AJ71UC24,	HG9Z-XC145	HG9Z-AC192	N/A
	MELSEC-QnA	Q4A, Q4AR, Q3A, Q2ACPU-S1, Q2ACPU		AJ71QC24N-R2, AJ71QC24N			
	MELSEC Q	Q02CPU, Q02HCPU, Q06HCPU, Q12PH-CPU, Q25HCPU	RS232	QJ71C24N-R2, QJ71C24, QJ71C24N	HG9Z-XC203	N/A	N/A
	MELSEC-FX	FX0, FX0N, FX1N, FX0S, FX1S	RS485(422)	Built-in Port	N/A	HG9Z-AC182	N/A
Siemens	S7-300	CPU 313-2PtP	RS485	Built-in Port	N/A	N/A	HG9Z-AC510

 Note: For complete listing of supported PLC/Host Device manufacturers/models type or protocols, wiring diagram, and setting details, please refer to WindOI-NV2 Users Manual - Communication Manual (pdf)
 N/A: Cable Not Available to purchase. For wiring diagram, refer to WindOI-NV2 Manual (pdf only) - Communication Manual.

High Performance Series Specifications

Display Specifications

	5.7"	8.4"	10.4"	12.1"
Model	HG2G-5FT22TF	HG3G-8JT22MF	HG3G-AJT22MF	HG4G-CJT22MF
Display Type	Color TFT LCD	Color TFT LCD	Color TFT LCD	Color TFT LCD
Color Depth	65,536	65,536	65,536	65,536
Portrait or Landscape Mounting	√	√	√	√
User Memory	12MB	12MB	12MB	12MB
Display Resolution	640W × 480H pixels	800W × 600H pixels	800W × 600H pixels	800W × 600H pixels
Backlight	LED	LED	LED	LED
Backlight Life ¹	50,000 hours	60,000 hours min.	60,000 hours min.	60,000 hours min.
Brightness ²	800 cd/m ²	600 cd/m ²	700 cd/m ²	550 cd/m ²
Brightness Adjustment	48 scales	48 scales	48 scales	48 scales
SD Card Slot	√	√	√	√
MicroSmart Digital I/O Cards Supported	2	4	4	4
Ethernet Port	1 RJ-45	1 RJ-45	1 RJ-45	1 RJ-45
USB Port	1 Type A and 1 mini-B	1 Type A and 1 mini-B	1 Type A and 1 mini-B	1 Type A and 1 mini-B
Serial Ports	2 (RS-232, RS-485, RS-422 configurable)	2 (RS-232, RS-485, RS-422 configurable)	2 (RS-232, RS-485, RS-422 configurable)	2 (RS-232, RS-485, RS-422 configurable)
Video In	–	Composite Video RCA connector (NTSC or PAL)	Composite Video RCA connector (NTSC or PAL)	Composite Video RCA connector (NTSC or PAL)
Audio In/Out	–	3.5mm audio mini-jack (Stereo)	3.5mm audio mini-jack (Stereo)	3.5mm audio mini-jack (Stereo)
Remote Monitor and Control	√	√	√	√

 1. The backlight life refers to the time until the surface brightness reduces by half after continuous use at 25°C.
 2. Brightness of the LCD only.

OI Touchscreens

PLCs

Automation Software

Power Supplies

Sensors

Communication

Barriers

General Specifications

	5.7"	8.4"	10.4"	12.1"
Model	HG2G-5FT22TF	HG3G-8JT22MF	HG3G-AJT22MF	HG4G-CJT22MF
Rated Power Voltage	24V DC	24V DC	24V DC	24V DC
Power Voltage Range	20.4 to 28.8V DC	20.4 to 28.8V DC	20.4 to 28.8V DC	20.4 to 28.8V DC
Power Consumption	19W maximum 10W maximum when not using USB interface (USB2) or expansion module interface (EXT)	25W maximum 15W maximum when not using USB interface (USB2) or expansion module interface (EXT)	27W maximum 18W maximum when not using USB interface (USB2) or expansion module interface (EXT)	27W maximum 18W maximum when not using USB interface (USB2) or expansion module interface (EXT)
Allowable Momentary Power Interruption	10 ms maximum	10 ms maximum	10 ms maximum	10 ms maximum
Inrush Current	30A maximum	30A maximum	30A maximum	30A maximum
Dielectric Strength	1,000V AC, 10 mA, 1 minute between power and FG terminals	1,000V AC, 10 mA, 1 minute between power and FG terminals	1,000V AC, 10 mA, 1 minute between power and FG terminals	1,000V AC, 10 mA, 1 minute between power and FG terminals
Insulation Resistance	10 MΩ minimum between power and FG terminals (500V DC megger)	10 MΩ minimum between power and FG terminals (500V DC megger)	10 MΩ minimum between power and FG terminals (500V DC megger)	10 MΩ minimum between power and FG terminals (500V DC megger)
Operating Temperature	0 to +50°C (no freezing)	0 to +50°C (no freezing)	0 to +50°C (no freezing)	0 to +50°C (no freezing)
Operating Humidity	10 to 90% RH (no condensation)	10 to 90% RH (no condensation)	10 to 90% RH (no condensation)	10 to 90% RH (no condensation)
Storage Temperature	-20 to +60°C (no freezing)	-20 to +60°C (no freezing)	-20 to +60°C (no freezing)	-20 to +60°C (no freezing)
Storage Humidity	10 to 90% RH (no condensation)	10 to 90% RH (no condensation)	10 to 90% RH (no condensation)	10 to 90% RH (no condensation)
Pollution Degree	2	2	2	2
Vibration Resistance	5 to 8.4 Hz amplitude 3.5 mm, 8.4 to 150 Hz, acceleration 9.8 m/s ² 10 cycles (100 minutes) on each of three mutually perpendicular axes	5 to 8.4 Hz amplitude 3.5 mm, 8.4 to 150 Hz, acceleration 9.8 m/s ² 10 cycles (100 minutes) on each of three mutually perpendicular axes	5 to 8.4 Hz amplitude 3.5 mm, 8.4 to 150 Hz, acceleration 9.8 m/s ² 10 cycles (100 minutes) on each of three mutually perpendicular axes	5 to 8.4 Hz amplitude 3.5 mm, 8.4 to 150 Hz, acceleration 9.8 m/s ² 10 cycles (100 minutes) on each of three mutually perpendicular axes
Shock Resistance	147 m/s ² , 11 ms 5 shocks on each of three mutually perpendicular axes	147 m/s ² , 11 ms 5 shocks on each of three mutually perpendicular axes	147 m/s ² , 11 ms 5 shocks on each of three mutually perpendicular axes	147 m/s ² , 11 ms 5 shocks on each of three mutually perpendicular axes
Noise Immunity	Fast transient/burst test, Power terminals: ±1 kV, Communication line: ±0.5 kV (IEC/EN61131-2: 2007)	Fast transient/burst test, Power terminals: ±2 kV, Communication line: ±1 kV (IEC 61131-2: 2007)	Fast transient/burst test, Power terminals: ±2 kV, Communication line: ±1 kV (IEC/EN61131-2: 2007)	Fast transient/burst test, Power terminals: ±2 kV, Communication line: ±1 kV (IEC/EN61131-2: 2007)
Electrostatic Discharge	ESD-3 (RH-1), Level 3 (Contact ±6 kV, air ±8 kV) (IEC/EN61131-2: 2007)	ESD-3 (RH-1), Contact ±6 kV, air ±8 kV (IEC 61131-2: 2007)	ESD-3 (RH-1), Level 3 (Contact ±6 kV, air ±8 kV) (IEC/EN61131-2: 2007)	ESD-3 (RH-1), Level 3 (Contact ±6 kV, air ±8 kV) (IEC/EN61131-2: 2007)
Corrosion Immunity	Free from corrosive gases	Free from corrosive gases	Free from corrosive gases	Free from corrosive gases
Degree of Protection	IP66 (IEC 60529) (front part when mounted) Type 4X, Type 13	IP66 (IEC 60529) (front part when mounted) Type 4X and 13	IP66 (IEC 60529) (front part when mounted) Type 4X and 13	IP66 (IEC 60529) (front part when mounted) Type 4X and 13
Switching Element	Analog resistive membrane	Analog resistive membrane	Analog resistive membrane	Analog resistive membrane
Operating Force	3N maximum	0.55 to 2.3N	0.55 to 2.3N	3N maximum
Mechanical Life	1,000,000 operations	1,000,000 operations	1,000,000 operations	1,000,000 operations
Sound Acknowledgement	Electronic buzzer	Electronic buzzer or speaker output	Electronic buzzer or speaker output	Electronic buzzer or speaker output
Dimensions	167.2W × 134.7H × 54.4D mm	231W × 176H × 54.4D mm	270W × 212H × 52.7D mm	314W × 240H × 54.1D mm
Weight (approx.)	0.65 kg	1.25 kg	1.65 kg	2.1 kg
Approvals	Safety Standards: UL508, CSA C22.2 No.142, Ship Classification Standards: ABS, LR, NK, DNV	Safety Standards: UL508, CSA C22.2 No.142, CSA C22.2 No.213, ANSI/ISA-12.12.01-2007 Ship Classification Standards: ABS, LR, NK, DNV, Type 4X and 13	Safety Standards: UL508, CSA C22.2 No.142, CSA C22.2 No.213, ANSI/ISA-12.12.01-2007 Ship Classification Standards: ABS, LR, NK, DNV, Type 4X and 13	Safety Standards: UL508, CSA C22.2 No.142, Ship Classification Standards: ABS, LR, NK, DNV, Type 4X and 13



Do not use the touchscreen in an environment subject to strong ultraviolet rays, otherwise the LCD quality will deteriorate.
*1 Protection degree of the front surface after mounting. Operation not guaranteed in certain environments.

HG2G-5T Series Specifications

Display Specifications

Model	5.7" HG2G-5TT	5.7" HG2G-5TN
Display	TFT Color LCD	TFT Monochrome LCD
Color/Shade	65,536	16 shades
Effective Display Area	115.2W × 86.4H mm	
Display Resolution	320W × 240H pixels	
View Angle	Right and left 80°, up 80°, down 80°	Right and left 65°, up 80°, down 60°
Backlight	LED	
Backlight Life	100,000 hours minimum*1	
Backlight Control	Automatic off	
Brightness	500 cd/m ² *2	1100 cd/m ² *2
Brightness Adjustment	32 levels	
Backlight Replacement	Not possible	

 *1 The backlight life refers to the time until the brightness reduces by half after use at 25°C.
*2 Brightness of the LCD only.

General Specifications

Model	HG2G-5TT (Color) / HG2G-5TN (Monochrome)
Rated Power Voltage	12 to 24 V DC
Power Voltage Range	10.2 to 28 VDC
Power Consumption	8W maximum 4W maximum when not using USB interface (USB2)
Allowable Momentary Power Interruption	10ms maximum (Voltage 20.4 to 28.8V DC) 1ms maximum (Voltage 10.2 to 20.4V DC)
Inrush Current	40A maximum
Dielectric Strength	1000V AC, 10 mA, 1 minute between power and FG terminals
Insulation Resistance	50 MΩ minimum between power and FG terminals (500V DC megger)
Operating Temperature	-20 to +60°C (no freezing)
Operating Humidity	10 to 90% RH (no condensation)
Storage Temperature	-20 to +70°C (no freezing)
Storage Humidity	10 to 90% RH (no condensation)
Pollution Degree	2
Vibration Resistance	5 to 8.4 Hz amplitude 3.5 mm, 8.4 to 150 Hz, acceleration 9.8 m/s ² 10 cycles (100 minutes) on each of three mutually perpendicular axes
Shock Resistance	147 m/s ² , 11 ms 5 shocks on each of three mutually perpendicular axes
Noise Immunity	Fast transient/burst test, Power terminals: ±2 kV, Communication line: ±1 kV (IEC/EN61000-4-4)
Electrostatic Discharge	ESD-3 (RH-1) Level 3 (Contact ±6 kV, air ±8 kV) (IEC/EN61000-4-2)

General Specifications, con't

Model	HG2G-5TT (Color) / HG2G-5TN (Monochrome)
Corrosion Immunity	Free from corrosive gases
Mounting	Panel mounting
Degree of Protection	IP66F (IEC 60529) (front part when mounted)*1 TYPE 4X TYPE 13 *2
Dimensions	167.2 W × 134.7 H × 40.9 D mm
Weight (approx.)	0.5 kg

 Do not use the HG2G in an environment subject to strong ultraviolet rays, otherwise the LCD quality will deteriorate.
*1 Protection degree of the front surface after mounting. Operation not guaranteed
*2 Operation not guaranteed when used with certain types of oils under certain environments.

Operation Specifications

Model	HG2G-5TT (Color) / HG2G-5TN (Monochrome)
Switching Element	Analog resistive membrane
Operating Force	3N maximum
Mechanical Life	1,000,000 operations
Acknowledgement Sound	Electronic buzzer

Function Specifications

Model	HG2G-5TT (Color) / HG2G-5TN (Monochrome)
Screen Types	Base screen, popup screen, system screen
No. of Screens	Base screen: 3,000 max. Popup screen: 3,015 max.
User Memory	5 MB (including expansion fonts)
Parts	Bit Button, Word Button, Goto Screen, Print Button Key Button, Multi Button, Keypad, Selector Switch, Potentiometer, Numerical Input, Character Input, Pilot Lamp, Multi-State Lamp, Picture Display, Message Display, Message Switching Display, Alarm List Display, Alarm Log Display, Numerical Display, Bar Graph, Trend Chart, Pie Chart, Meter, Calendar, Bit Write Command, Word Write Command, Goto Screen Command, Print Command Screen Script Command, Multi Command, Timer
Calendar	Year, Month, Day, Hour, Min., Sec., Day of Week ±60 sec per month (at 25 °C)
Power Failure Backup Data	Calendar, log data, keep internal relay, keep internal register
Battery	Recommended replacement span: every 4 years (at 25°C)

OI Touchscreens

PLCs

Automation Software

Power Supplies

Sensors

Communication

Barriers

Interface Specifications

Model	HG2G-5TT (Color) / HG2G-5TN (Monochrome)		
Serial Interface 1 (COM1)*	RS232C	Electrical Characteristics	EIA RS232C compliant
		Transmission Speed	1200, 2400, 4800, 9600, 19200, 38400, 57600, 115200 bps
		Synchronization	Asynchronous
		Communication Method	Half or full duplex
		Control System	Hardware control or none
	Connector	Detachable 9-pin terminal block	
	EIA RS422/485	Electrical Characteristics	EIA RS422/485 compliant
		Transmission Speed	1200, 2400, 4800, 9600, 19200, 38400, 57600, 115200, 187500 bps (Note)
		Synchronization	Asynchronous
		Communication Method	Half or full duplex
Control System		None	
Connector	Detachable 9-pin terminal block		
Ethernet Interface (LAN)	Interface	IEEE802.3u (10BASE-T/100BASE-TX) compliant	
	Connector	Connector (RJ-45)	
USB Interface (USB2)	Interface	USB 2.0 full speed (12 Mbps)	
	Connector	USB Type Mini-A connector	
USB Interface (USB1)	Interface	USB 2.0 high speed (480 Mbps)	
	Connector	USB Type Mini-B connector	

*RS232C and RS 422/485 can be used simultaneously.
 Note: 187,500 bps is available only with SIEMENS SIMATIC S7-300/400 series (MPI port direct connection).

General Specifications

Model	4.6" HG1F Monochrome
Voltage	24V DC
Voltage Range	20.4 to 28.8V DC
Power Consumption	10W maximum
Inrush Current	20A maximum
Allowable Momentary Power Interruption	10 ms minimum
Dielectric Strength	1,000V AC, 10 mA, 1 minute between power and FG terminals
Insulation Resistance	50 MΩ minimum between power and FG terminals (500V DC megger)
Backup Battery	CR2032 lithium battery Life approx. 4 years (25°C)
Operating Temperature	0 to 50°C (no freezing)
Operating Humidity	10 to 90% RH (no condensation)
Storage Temperature	-20 to +60°C (no freezing)
Storage Humidity	10 to 90% RH (no condensation)
Pollution Degree	2 (IEC 60664-1)
Corrosion Immunity	Atmosphere free from corrosive gases
Vibration Resistance (damage limits)	10 to 20Hz amplitude 0.625 mm, 20 to 55Hz acceleration 9.8 m/s ² (1G), 2 hours per axis on each of three mutually perpendicular axes
Shock Resistance (damage limits)	147 m/s ² (15G), 11 ms, 5 shocks on each of three mutually perpendicular axes

General Specifications, con't

Model	4.6" HG1F Monochrome
Noise Immunity	Fast transient/burst test, common mode: Level 3, power terminals: ±2 kV, communication line: ±1 kV (IEC/EN 61000-4-4)
Electrostatic Discharge	ESD-3 (RH-1), Level 3, (contact ±6 kV, aerial ±8 kV) (IEC/EN 61000-4-2)
Mounting	Panel mounting
Degree of Protection	IP65 TYPE 13, ANSI/ISA-12.12.01-2007
Dimensions (mm)	147W x 47H x 39.3D
Weight (approx.)	280g

Operation Specifications

Model	4.6" HG1F Monochrome
Switching Element	Resistive membrane
Touch Region Resolution	1 x 1
CC Switch Quantity	
Operating Force	0.2 to 0.8N
Mechanical Life	1,000,000 operations
Acknowledge Sound	Electronic buzzer
Screen Types	Base screen, popup screen, system screen
Number of Screens	Base screen: 3000 max., popup screen: 3015 max.
User Memory	1MB (including expansion fonts)
Parts	Bit Button, Word Button, Goto Screen Button, Print Button, Key Button, Keypad, Selector Switch, Potentiometer, Numerical Input, Character Input, Pilot Lamp, Multi-state Lamp, Picture Display, Message Display, Message Switching Display, Alarm List Display, Alarm Log Display, Numerical Display, Bar Graph, Trend Chart, Pie Chart, Meter, Calendar, Bit Write Command, Word Write Command, Goto Screen Command, Timer, Print Command, Screen Script Command
Calendar	Year, Month, Day, Hour, Min., Sec., Day of Week
Print Function (support)	ESC/P, PC-PR: Epson VP-700 SII: DPU414
Power Failure Backup	Backup data: Calendar, log data, keep internal relay, keep internal register
Backup Duration	1 month (at 25°C) after full charging for two days
Battery Life	4 years (at 25°C)

 *2MB for OS

High-Performance Series Dimensions and Panel Cutouts (mm)

5.7" HG2G-5FT22TF

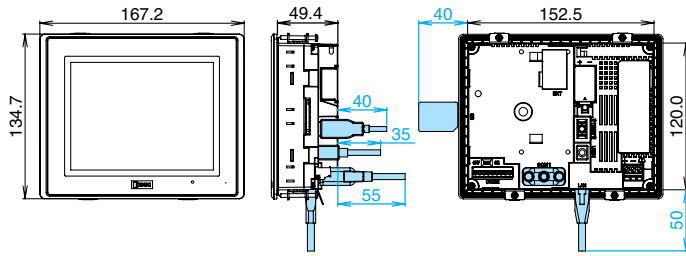

Panel Cut-out

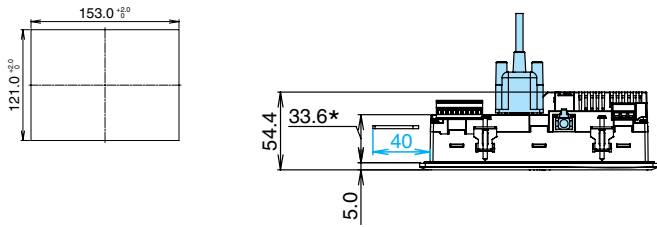

8.4" HG3G-8JT22MF

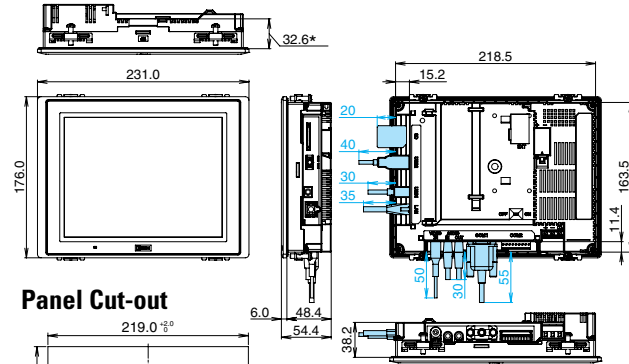

Panel Cut-out

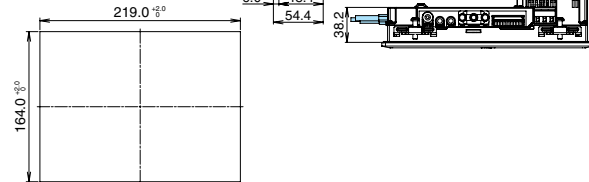

10.4" HG3G-AJT22MF

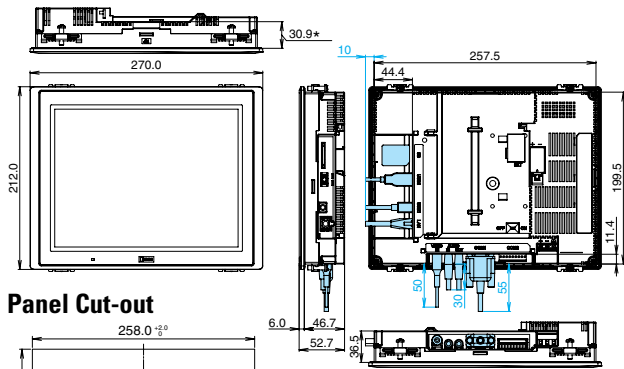

Panel Cut-out

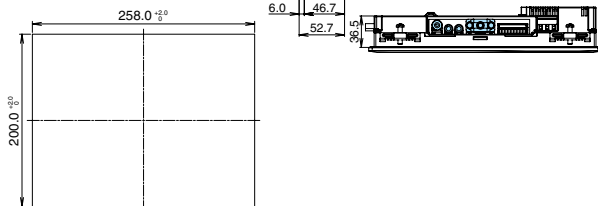

12.1" HG4G-CJT22MF

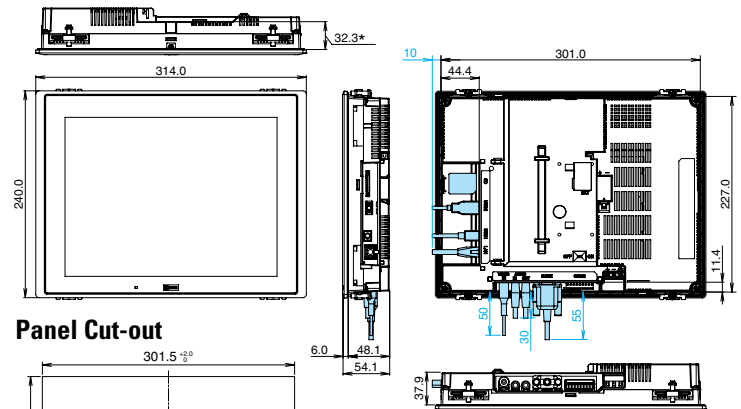

Panel Cut-out

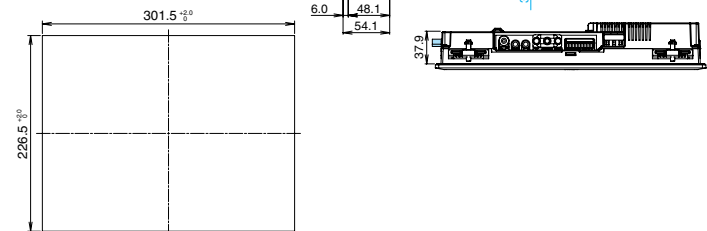

1. Dimensions in blue show the mounting dimensions of the cable.
2. Dimensions in the figure vary depending on the type of cable connected.

HG2G-5T Series Dimensions and Panel Cutouts (mm)

5.7" HG2G-5TT22TF/HG2G-5TN22TF

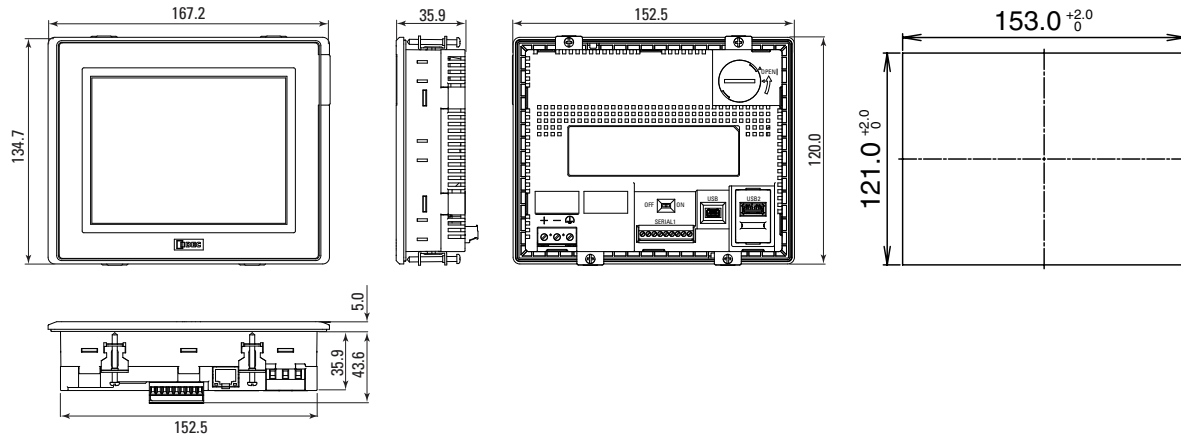

4.6" HG1F (Monochrome)

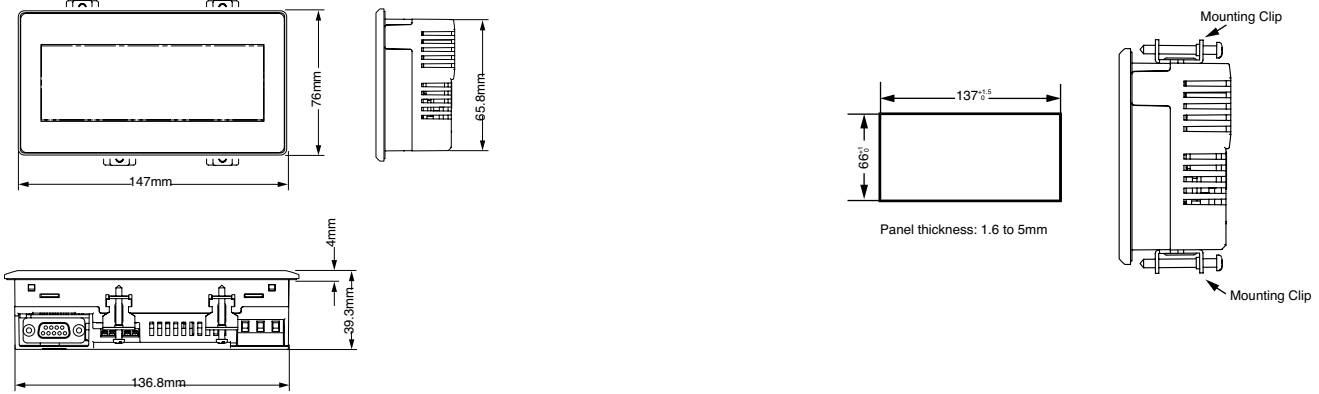

1. Dimensions in blue show the mounting dimensions of the cable.
2. Dimensions in the figure vary depending on the type of cable connected.
3. Install the HG2G into a panel cut-out by tightening the four mounting clips (supplied) to a torque of 0.2 to 0.3 N·m. Do not tighten with excessive force, otherwise the HG2G and screen may be distorted. Also waterproof characteristics may be lost.

OI Touchscreens

PLCs

Automation Software

Power Supplies

Sensors

Communication

Barriers