



Think Automation and beyond...



IDEC LUMIFA Family
LED Lighting Solutions

LUMIFA

Lighting your way

For over three decades, IDEC has produced LEDs for applications requiring indicator lights and signaling towers. That is why it was a natural progression to begin developing lighting products and construct the world's first building illuminated with 100% of our own LED technology. New LUMIFA LED lights provide a brighter, longer-lasting, cost-effective and more environmentally-friendly lighting source.

- **Bright:**
65.3 lumens/watt (LUMIFA series average)
- **Long Lasting:**
70% of initial luminance at 50,000 hrs
- **Efficient:**
1/3 the energy of Fluorescent Tubes
- **Compact:**
Width as narrow as 25mm
- **Rugged:**
Heavy-duty, durable, water/oil resistant
- **Variety of Colors:**
Cool white, warm white, red, yellow, blue, green
- **Greatest Selection:**
More choices in size, brightness, color, applications and ratings



Suitable for Harsh Environments

With their IP67/IP67f and IP69K ratings, the LF1D and 2D series can be used in wet and harsh environments. Resistant to water, oil and metal shavings, they are perfect for many industrial applications. In addition, the LF1E series can withstand temperatures down to -40°C making them ideal for freezers and refrigerated environments. And, don't forget the EF1A series that has an IP67 rating and can be used in Class 1, Zone 1 and Zone 2 hazardous locations.

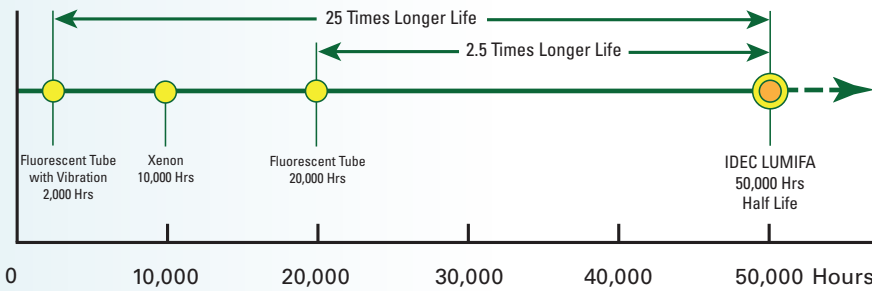

Heat Dissipation Technology

In an LED, only 20% of the energy converts into light, while 80% is lost in the form of heat. For that reason, proper heat management is critical. IDEC Heat Dissipation Technology (patent pending) uses dissipation pins to transfer heat generated in the LED chip to a heat dissipation plate. This minimizes the buildup of heat in the LED element and results in a longer-lasting LED.

Environmentally-friendly

LUMIFA LEDs are made from non-toxic materials and produce 71% less CO₂ emissions compared with a 20W/25W fluorescent tube. LUMIFA are also great for green applications such as solar panels, which have a low power requirement and can't supply the energy necessary for fluorescent bulbs.

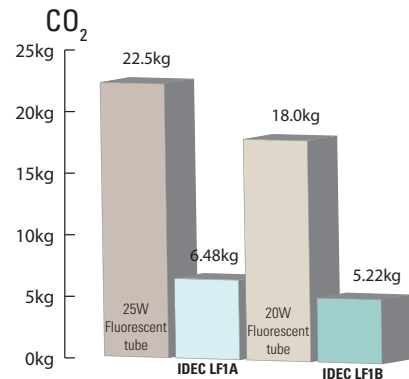

800.262.4332

www.IDEC.com/usa/LED

LUMIFA

Selection Guide

Selection Guide				Application Examples	Illumination Color ¹	Reference Illumination ²	Power Consumption	Operating Voltage	Page		
LF1D/2D	Mini	LF1D-C (IP67f/IP67/IP69K)		<ul style="list-style-type: none"> · Machine tools · Food processing machines · Automatic manufacturing machines · Printing machines · Production system · Test equipment 	White (5,700K)	180lx	4.6W	24V DC	6		
	Slim and Wide	LF1D/2D Classic (IP67f/IP67)	Slim		<ul style="list-style-type: none"> · Machine tools · Food processing machines · Test equipment 	White (5,700K)	Clear Surface: 1,100lx (4,400lx directly below at .5m)	9W		24V DC	
			Wide					Diffused surface: 1,000lx (4,000lx directly below at .5m)			12.5W
		LF1D/2D-*H Wide-angle and High Luminance (IP67f/IP67/IP69K)	Slim		<ul style="list-style-type: none"> · Machine tools · Food processing machines · Automatic manufacturing machines · Printing machines · Production system · Test equipment 	White (5,700K)	1,450lx	11W		24V DC	
			Wide					1,200lx			12.5W
	Long	LF1D-H (IP67f/IP67/IP69K)		<ul style="list-style-type: none"> · Machine tools · Food processing machines · Automatic manufacturing machines · Printing machines · Production system · Test equipment 	Neutral White (4,700K) ³	560lx	18.4W	24V DC			
		LF1D-J (IP67f/IP67/IP69K)					840lx			27.6W	
	LF2B (IP65)	Clear Cover	White Cover		<ul style="list-style-type: none"> · Various machines and systems · Control panel · Plant · Solar power equipment 	White (5,500K)	LF2B-B: 290lx LF2B-C: 540lx LF2B-D: 1065lx LF2B-E: 1385lx LF2B-F: 1520lx	12/24V DC LF2B-B: 2.6W LF2B-C: 4.9W LF2B-D: 10.6W		12/24V DC	11
								100 to 240V AC LF2B-B: 3.8W LF2B-C: 7.5W LF2B-D: 9.2W LF2B-E: 14.3W LF2B-F: 21.8W			

1. K: Color Temperature (typ.), mm: Dominant Wavelength (typ.).

2. Directly below at 1m unless otherwise noted.

3. To match traditional cool fluorescent lamps.

			Application Examples	Illumination Color ¹	Reference Illumination ²	Power Consumption	Operating Voltage	Page
LF1B-N (IP65)	Clear/White Cover		<ul style="list-style-type: none"> · Machine tool · Plant equipment · Test equipment · Control panel 	Cool white (5,500K)	LF1B-NA: 90lx LF1B-NF: 935lx	Cool white/Warm white/Blue LF1B-NA: 1.5W LF1B-NB: 2.9W LF1B-NC: 4.4W LF1B-ND: 8.7W LF1B-NE: 13.0W LF1B-NF: 17.3W Yellow/Red/Green LF1B-NA: 1.0W LF1B-NB: 2.0W LF1B-NC: 2.9W LF1B-ND: 5.8W LF1B-NE: 8.7W LF1B-NF: 11.6W	24V DC	13
			<ul style="list-style-type: none"> · Food processing machines · Cosmetic plant · Chemical plant · Show cases 	Warm white (2,900K)	LF1B-NA: 60lx LF1B-NF: 620lx			
			<ul style="list-style-type: none"> · Semiconductor manufacturing equipment · IC foundry 	Yellow (590nm)	LF1B-NA: 20lx LF1B-NF: 180lx			
			<ul style="list-style-type: none"> · Photosensitive material · Semiconductor manufacturing equipment · Darkroom experiment 	Red (620nm)				
			<ul style="list-style-type: none"> · Advertising Display · Light ornaments 	Blue (455nm)	LF1B-NA: 10lx LF1B-NF: 80lx			
				Green (525nm)	LF1B-NA: 30lx LF1B-NF: 300lx			
LF1A (IP40)	Clear Cover		<ul style="list-style-type: none"> · Control Panels · Manufacturing Equipment 	Cool white (5,500K)	LED Array 3x2: 190lx LED Array 6x2: 380lx LED Array 12x2: 760lx	LED Array 3x2: 1.8W LED Array 6x2: 3.6W LED Array 12x2: 7.2W	24V DC	15
				Warm white (2,800K)	LED Array 3x2: 130lx LED Array 6x2: 260lx LED Array 12x2: 52lx			
				Yellow (590nm)	LED Array 3x2: 130lx LED Array 6x2: 260lx LED Array 12x2: 52lx	LED Array 3x2: 2.2W LED Array 6x2: 4.4W LED Array 12x2: 8.7W		
				Red (625nm)	LED Array 3x2: 85lx LED Array 6x2: 170lx LED Array 12x2: 340lx			
EF1A (IP67)		For Hazardous Locations: <ul style="list-style-type: none"> · Oil, gas and mining industries · Printing factory · Gas station · Chemical complex control panel 	White (5,700K)	Clear glass surface: 1,100lx (condensing light) 205lx (diffused light) Translucent glass: 450lx (condensing light) 175lx (diffused light)	19W 17W	100 to 240V AC 24V DC	17	
LF1F		<ul style="list-style-type: none"> · Visual inspection · Elevator ceiling 	8,500K	5,800lx	11W	21.6 ~ 26.4V DC	19	

1. K: Color Temperature (typ.), mm: Dominant Wavelength (typ.).

2. Directly below at .5m unless otherwise noted.

LUMIFA LF1D and LF2D

Machine Tools • Food and Beverage Processing Equipment • Vision Systems

LF1D (IP69K) and LF2D (IP67, IP67f) Series

With their rugged construction, the LF1D/2D series of light units are ideal for machine tools, automated label and package inspection equipment, and food and beverage processing equipment. Their design provides equally brilliant light at the center or edges of the units. Plus with their ratings, the LF1D (IP67, IP67f, IP69K) and LF2D (IP67, IP67f) can be used where high-pressure and high-temperature washdowns are used.

Mini (LF1D-C)

- Compact unit only 100 x 50 x 25mm
- Single LED module design eliminates multiple shadows while distributing light over a wide area (120°)

Slim and Wide (LF1D/2D-E, EH, F, FH)

- Brightness: Standard Models: up to 1,100lx at 1m
High-Luminance Models: up to 1,450lx at 1m
- Available with terminal block or spring clamp connections for easy installation
- Angle adjustable mounting brackets provide installation flexibility

Long (LF1D-H/J)

- Two lengths available: 365mm and 510mm
- The flat light design reduces glare and multiple shadows, improving visibility from a distance



LED Optical Specifications

Model	Mini	Standard				High-Luminance				Long	
	LF1D-C	Slim (LF1D/2D-E)	Wide (LF1D/2D-F)	Slim (LF1D/2D-EH)	Wide (LF12D-FH)	LF1D-H	LF1D-J				
Illumination Surface	Clear	Clear	Diffused	Clear	Diffused	Clear	Diffused	Clear	Diffused	Clear	
Illumination Color	Cool White								Neutral White		
Total Luminous Flux	560lm	600lm	840lm	1,000lm	1,260lm	2,000lm	3,000lm	LED modules and illumination units may vary in color and brilliance. Luminous flux, color temperature, and illuminance values shown above are typical.			
Color Temperature	5700K								4700K		
Reference Illuminance at 1.0m	180lx	1,100lx	1,000lx	1,100lx	1,000lx	1,450lx	1,200lx	1,450lx	1,200lx	560lx	840lx

General Specifications

Model	Mini	Standard		High-Luminance		Long	
	LF1D-C	Slim (LF1D/2D-E)	Wide (LF1D/2D-F)	Slim (LF1D/2D-EH)	Wide (LF1D/2D-FH)	LF1D-H	LF1D-J
Rated Voltage	24V DC						
Voltage Range	21.6 to 26.4V DC						
Rated Power (typ.)	4.6W	9W	12.5W	11W	12.5W	18.4W	27.6W
Insulation Resistance	100MΩ minimum (500V DC megger)						
Dielectric Strength	1,000V AC, 50/60Hz, 1 minute						
Vibration Resistance (damage limits)	Frequency 5 to 55Hz, amplitude 0.5mm						
Shock Resistance (damage limits)	1000m/s ²						
Operating Temperature	-30 to +55°C (no freezing)						
Operating Humidity	45 to 85% RH (no condensation)						
Storage Temperature	-35 to +70°C (no freezing)						
Operating Environment	No corrosive gases						
Life ¹	50,000 hours (The illumination duration in which the illuminance maintains a minimum of 70% of the initial value at 25°C.)						
Degree of Protection ²	IP67f (LF2D: reinforced glass), IP67 (LF2D: polycarbonate), IP69K (LF1D)						
Material ³	Housing: Diecast aluminum (LF1D/LF2D), Lens: Reinforced glass or polycarbonate (LF1D/LF2D) Cover: Stainless steel (LF1D), Flange cover: Diecast aluminum (LF2D)						
Weight (approx.)	420g	LF1D-E*-2W*: 750g LF1D-E*-2W-A*: 950g LF2D-E*-2W*: 850g LF2D-E*-2W-A*: 1,000g	LF1D-F*-2W*: 800g LF1D-F*-2W*: 1,000g LF2D-F*-2W*: 900g LF2D-F*-2W-A*: 1,050g	LF1D-E*-2W*: 750g LF1D-E*-2W-A*: 950g LF2D-E*-2W*: 850g LF2D-E*-2W-A*: 1,000g	LF1D-F*-2W*: 800g LF1D-F*-2W*: 1,000g LF2D-F*-2W*: 900g LF2D-F*-2W-A*: 1,050g	1200g	1600g

1. LED life depends on the operating environment.

2. Waterproof or oil-proof characteristics specified by IEC 60529 and JEM1030. For illumination units without accessories, use a cable gland and cables that satisfy IP67f or IP67 degree of protection.

3. The reinforced glass and polycarbonate illumination surfaces have the same appearance, but have different degrees of protection (IP67f or IP67).

Part Numbers

Mini (LF1D-C)

Location	Cable		Part Number
	Length		
Side	3m		LF1D-C2F-2W-330
	5m		LF1D-C2F-2W-350
Back	3m		LF1D-C2F-2W-430
	5m		LF1D-C2F-2W-450

Long (LF1D-H 365mm)

Location	Cable		Part Number
	Length		
Side	5m		LF1D-H2F-2N-350
	1.5m + M12 connector		LF1D-H2F-2N-3B0
Back	5m		LF1D-H2F-2N-450
	1.5m + M12 connector		LF1D-H2F-2N-4B0

Long (LF1D-J 510mm)

Location	Cable		Part Number
	Length		
Side	5m		LF1D-J2F-2N-350
	1.5m + M12 connector		LF1D-J2F-2N-3B0
Back	5m		LF1D-J2F-2N-450
	1.5m + M12 connector		LF1D-J2F-2N-4B0

Slim and Wide Surface Mounting (LF1D/-E, EH, F, FH)

Cable Gland LF9Z-A11	Model		Slim Model (10 LEDs × 1 row)		Wide Model (7 LEDs × 2 rows)	
	Cable LF9Z-C05	Mounting Bracket LF9Z-B11,B12	Clear Reinforced Glass	Clear Polycarbonate	Clear Reinforced Glass	Clear Polycarbonate
—	—	—	LF1D-E⊙2F-2W	LF1D-E⊙3G-2W	LF1D-F⊙2F-2W	LF1D-F⊙3G-2W
(hole on the side)	—	√	LF1D-E⊙2F-2W-101	LF1D-E⊙3G-2W-101	LF1D-F⊙2F-2W-101	LF1D-F⊙3G-2W-101
—	—	—	LF1D-E⊙2F-2W-200	LF1D-E⊙3G-2W-200	LF1D-F⊙2F-2W-200	LF1D-F⊙3G-2W-200
(hole on the back)	—	√	LF1D-E⊙2F-2W-201	LF1D-E⊙3G-2W-201	LF1D-F⊙2F-2W-201	LF1D-F⊙3G-2W-201
—	—	—	LF1D-E⊙2F-2W-300	LF1D-E⊙3G-2W-300	LF1D-F⊙2F-2W-300	LF1D-F⊙3G-2W-300
√	—	√	LF1D-E⊙2F-2W-301	LF1D-E⊙3G-2W-301	LF1D-F⊙2F-2W-301	LF1D-F⊙3G-2W-301
(Side)	√	—	LF1D-E⊙2F-2W-350	LF1D-E⊙3G-2W-350	LF1D-F⊙2F-2W-350	LF1D-F⊙3G-2W-350
—	√	√	LF1D-E⊙2F-2W-A	LF1D-E⊙3G-2W-A	LF1D-F⊙2F-2W-A	LF1D-F⊙3G-2W-A
—	—	—	LF1D-E⊙2F-2W-400	LF1D-E⊙3G-2W-400	LF1D-F⊙2F-2W-400	LF1D-F⊙3G-2W-400
√	—	√	LF1D-E⊙2F-2W-401	LF1D-E⊙3G-2W-401	LF1D-F⊙2F-2W-401	LF1D-F⊙3G-2W-401
(Back)	—	—	LF1D-E⊙2F-2W-450	LF1D-E⊙3G-2W-450	LF1D-F⊙2F-2W-450	LF1D-F⊙3G-2W-450
—	√	√	LF1D-E⊙2F-2W-451	LF1D-E⊙3G-2W-451	LF1D-F⊙2F-2W-451	LF1D-F⊙3G-2W-451

*In place of ⊙ insert H for High-Luminance or leave blank for Standard models.

Slim and Wide Recessed Mounting (LF2D/-E, EH, F, FH)

Cable Gland LF9Z-A11	Cable LF9Z-C05	Slim Model (10 LEDs × 1 row)		Wide Model (7 LEDs × 2 rows)	
		Clear Reinforced Glass	Clear Polycarbonate	Clear Reinforced Glass	Clear Polycarbonate
—	—	LF2D-E⊙2F-2W	LF2D-E⊙3G-2W	LF2D-F⊙2F-2W	LF2D-F⊙3G-2W
—	—	LF2D-E⊙2F-2W-200	LF2D-E⊙3G-2W-200	LF2D-F⊙2F-2W-200	LF2D-F⊙3G-2W-200
—	—	LF2D-E⊙2F-2W-300	LF2D-E⊙3G-2W-300	LF2D-F⊙2F-2W-300	LF2D-F⊙3G-2W-300
√	√	LF2D-E⊙2F-2W-A	LF2D-E⊙3G-2W-A	LF2D-F⊙2F-2W-A	LF2D-F⊙3G-2W-A
(Side)	—	LF2D-E⊙2F-2W-400	LF2D-E⊙3G-2W-400	LF2D-F⊙2F-2W-400	LF2D-F⊙3G-2W-400
—	√	LF2D-E⊙2F-2W-450	LF2D-E⊙3G-2W-450	LF2D-F⊙2F-2W-450	LF2D-F⊙3G-2W-450
(Back)	—	LF2D-E⊙2F-2W-450	LF2D-E⊙3G-2W-450	LF2D-F⊙2F-2W-450	LF2D-F⊙3G-2W-450

*In place of ⊙ insert H for High-Luminance or leave blank for Standard models.

Accessories

Item	Mounting Bracket				Cable Gland	Cable
	Fixed		Adjustable Angle			
Part Number	LF9Z-B11	LF9Z-B12	LF9Z-1MDE1	LF9Z-1MDF1	LF9Z-A11	LF9Z-C05
Applicable Unit	LF1D (Slim)	LF1D (Wide)	LF1D (Slim)	LF1D (Wide)	LF1D/2D (Slim and Wide)	
Material	Stainless Steel				Brass	PVC
Notes	1 pair, Left and Right				M8*	Length: 5m

*Applicable wire size (10-12 AWG)

LF1D and LF2D

Part Number Structure (use for interpreting part numbers only)

LF 2 D - E H 2 F - 2 W - 300

Shape
 1: Surface mount
 2: Recessed mount

Size (LED arrangement)
 C: Mini 100mm (3.94")
 E: Slim Model (10 LEDs × 1 row)
 F: Wide Model (7 LEDs × 2 rows)
 H: Long 365mm (14.37")
 J: Long 510mm (20.08")

Illumination Models (Wide and Slim only)
 blank: Standard
 H: large area, High Luminance

Degree of Protection
 F: Clear reinforced glass
 IP67 (LF2D),
 IP67/IP69K (LF1D)

Illumination Color
 W: white
 N: neutral

Illumination Surface
 2: Clear, Reinforced glass
 3: Clear, Polycarbonate
 5: Diffused, Polycarbonate (standard wide and slim)
 9: Diffused, Reinforced glass (standard wide and slim)

Cable Gland

Code	Cable Gland	Cable Gland Hole Location	Cable	Mounting Bracket
Blank	-	side	-	-
A	√	side	5m	√ ¹
101	-	side	-	√ ¹
200	-	back	-	-
201	-	back	-	√ ¹
300	√	side	-	-
3B0	√	side	1.5m ³	-
301	-	side	-	√ ¹
330	√	side	3m	-
350 ²	√	side	5m	-
400	-	back	-	-
401	-	back	-	√ ¹
430	√	back	3m	-
450	√	back	5m	-
451	√	back	5m	√ ¹
4B0	√	back	1.5m ³	-

1. Mounting bracket available for LF1D (wide and slim) only.
2. Only available for LF1D (wide and slim) models.
3. 1.5m cable with M12 connector for Long only (LF1D-H, J).

Terminal Block Wiring

Slim Type

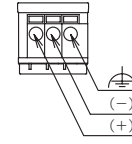

Wide Type

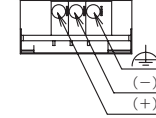

Applicable ferrules: 0.25 to 0.75 mm²

Recommended source - Phoenix Contact:
 AI 0,25-12 BU, AI 0,34-12 TQ,
 AI 0,5-12 WH, AI 0,75-12 GY

Illuminance Charts

LF1D-C

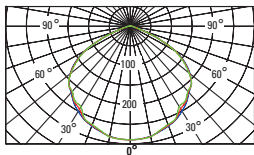

LF1D/2D-EH

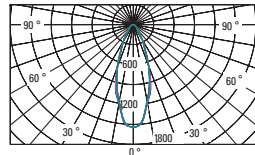

LF1D/2D-FH

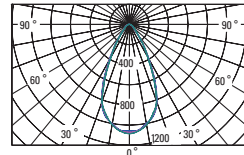

LF1D-H

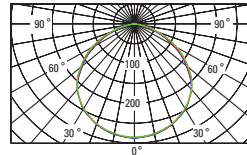

LF1D-J

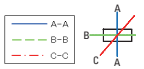
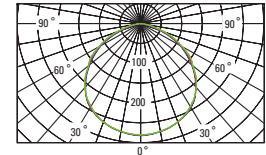

Internal Circuit

LF1D-C

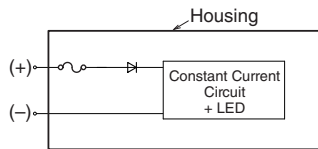

LF1D/2D-E, EH, F, FH

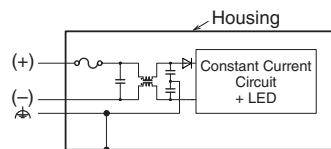

LF1D-H/J

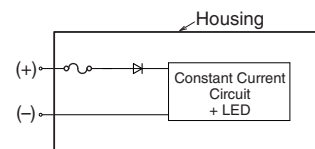

Distribution Characteristics

LF1D-C

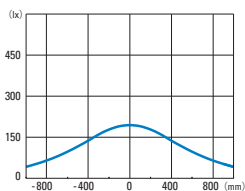

LF1D/2D-EH

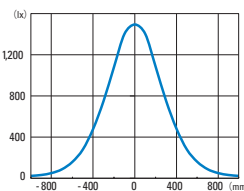

LF1D/2D-FH

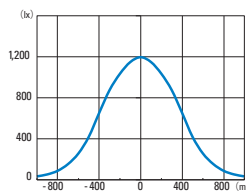

LF1D-H

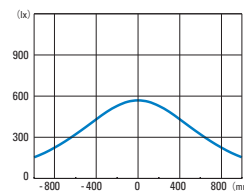

LF1D-J

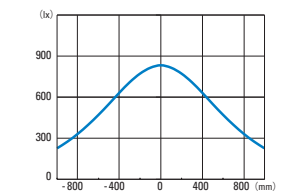

Dimensions (mm)

LF1D-C Mini

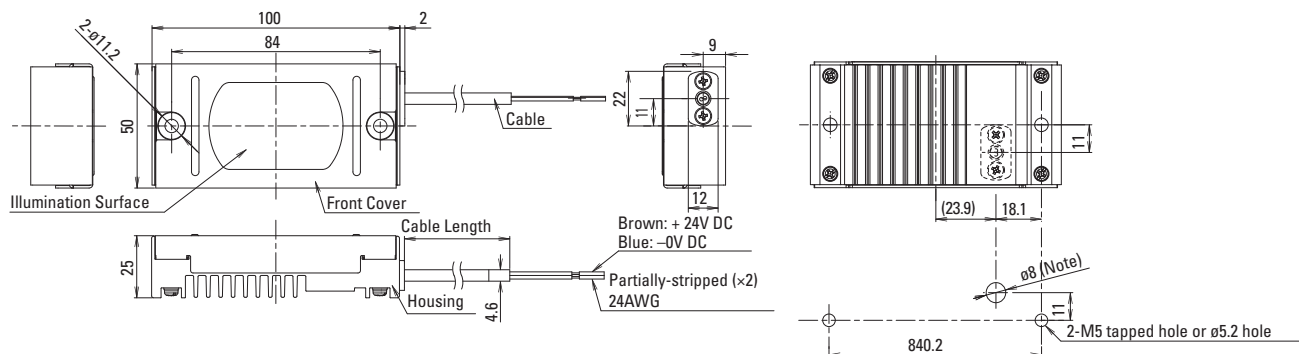

Dimensions (mm)

LF1D Slim

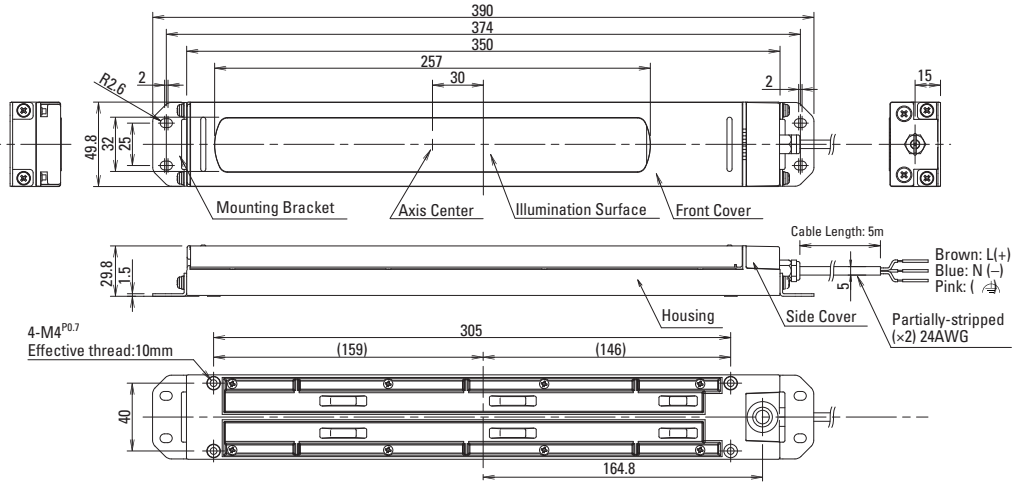

LF2D Slim

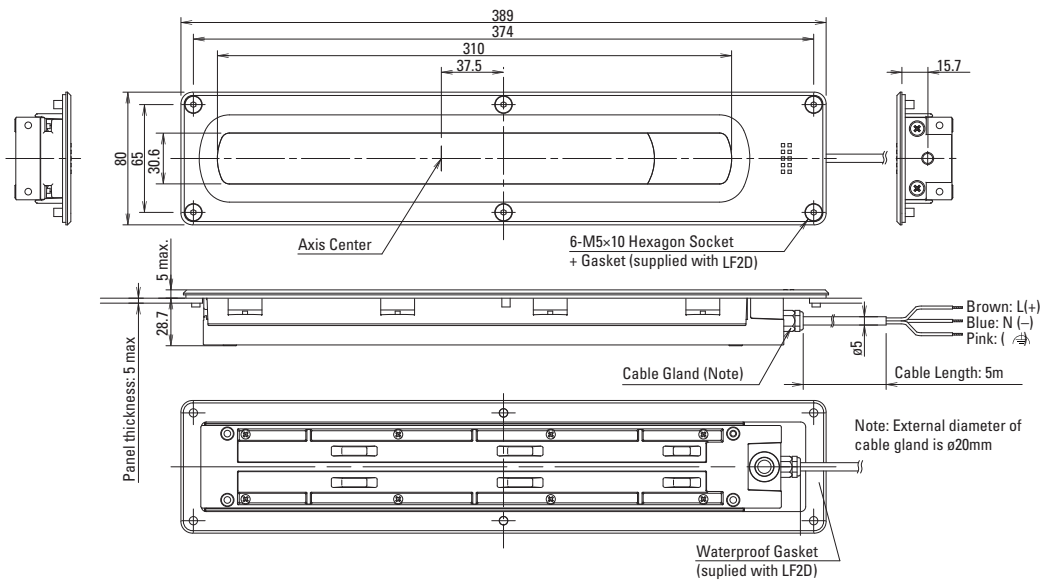

LF1D Wide

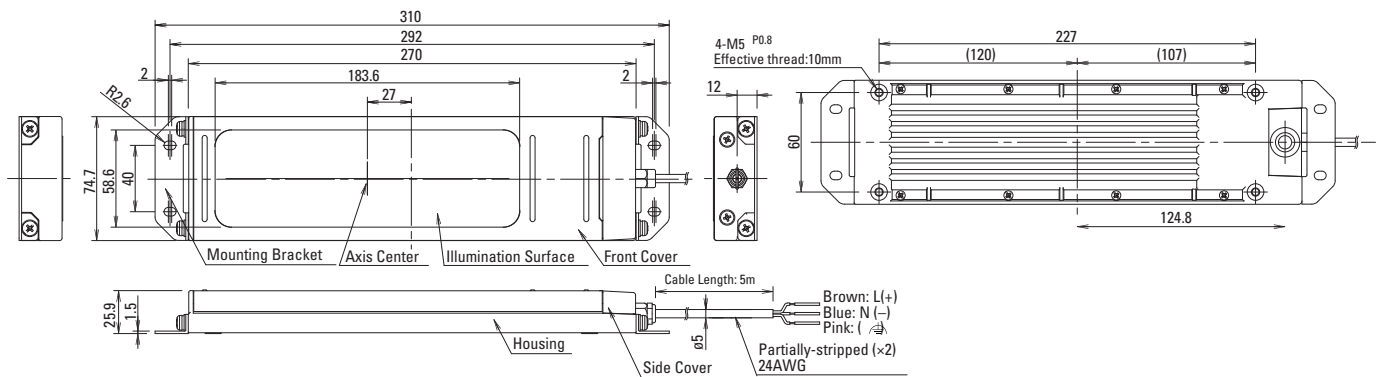

LF1D and LF2D

LF2D Wide

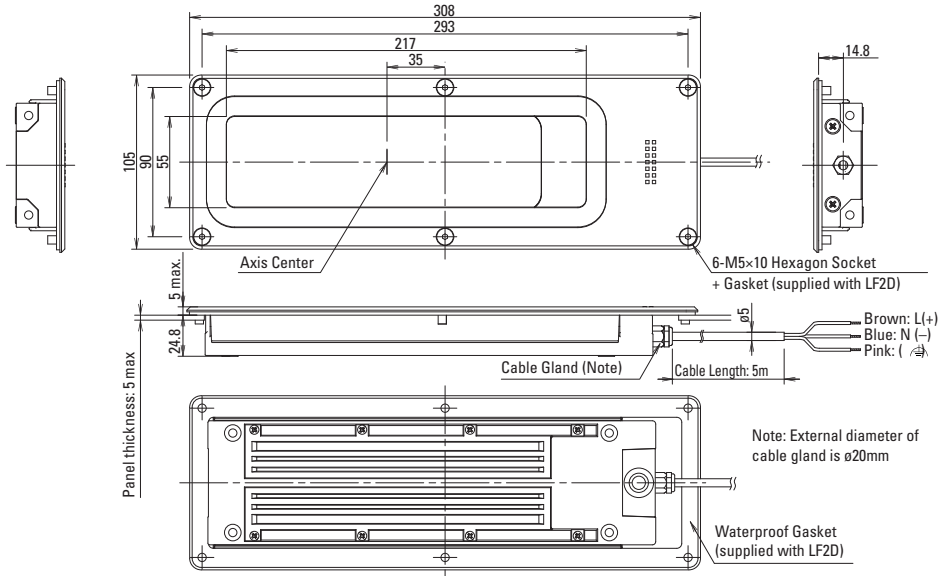

LF1D-H Long

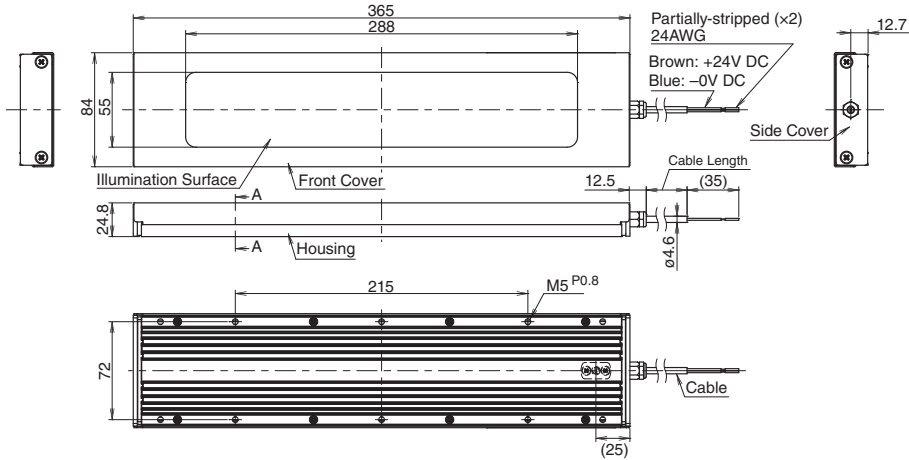

LF1D-J Long

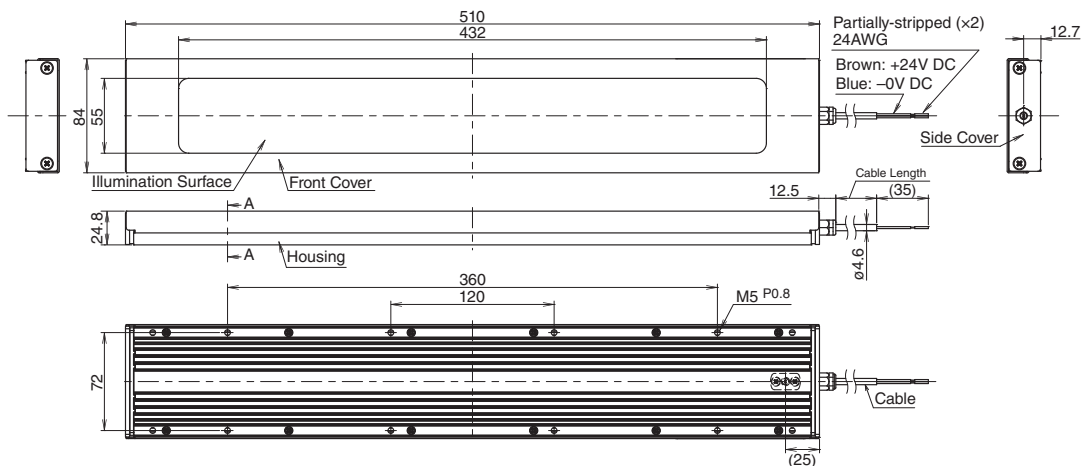

LUMIFA LF2B

Control Panels • Industrial Equipment • Commercial Products

LF2B Series

Wide range of input voltages (100 - 240V AC) for commercial applications, and 12/24V DC are available for battery or industrial usage. Slim units can be used in many applications and installations where space is limited. Rated IP65 (protection from water and dust), LF2B is great for environments where there is water spray.

- Slim units: 40mm wide x 29mm high
- One-step installation in a narrow space is possible when using mounting brackets
- Five Lengths (210/330/580/830/1,080mm) are offered to meet space requirements and illumination coverages
- Bright and clear white LED illuminates the shapes and colors of target objects
- Two covers: clear or white



*UL applies for DC units only.

LED Optical Specifications

Model	LF2B-B (210mm)		LF2B-C (330mm)		LF2B-D (580mm)		LF2B-E (830mm)		LF2B-F (1,080mm)	
Illumination Color	White									
Color Temperature	5,500K									
Luminous Flux (typ.)	180lm		360lm		720lm		1,080lm		1,440lm	
Cover	Clear	White	Clear	White	Clear	White	Clear	White	Clear	White
Reference Illuminance (typ.) at 0.5m directly below	230lx	215lx	425lx	390lx	710lx	645lx	930lx	835lx	1,160lx	1,040lx

LED modules and illumination units may vary in illumination colors and illuminance.

General Specifications

Model	LF2B-B (210mm)	LF2B-C (330mm)	LF2B-D (580mm)	LF2B-E (830mm)	LF2B-F (1,080mm)	
Rated Voltage	100-240V AC 50/60Hz (Voltage range: 90-264V AC) 12V/24V DC (Voltage range: 10.8-30V DC)					
Input Current (typical) (at the rated voltage) ¹	AC100-240V AC	33mA	67mA	96mA	149mA	226mA
	12V/24V DC	215mA	409mA	880mA	-	-
Rated Power (at the rated voltage)	100-240V AC	3.8W	7.5W	9.2W	14.3W	21.8W
	12V/24V DC	2.6W	4.9W	10.6W	-	-
Insulation Resistance	100MΩ minimum (500V DC megger)					
Dielectric Strength	100-240V AC	2,000V AC			-	
	12V/24V DC	1,000V AC			-	
Vibration Resistance	Frequency 5 - 55Hz, Amplitude 0.17mm, speed acceleration 20m/s ² , 3 directions, 2 hours each					
Shock Resistance	300m/s ² , 6 directions, 5 times each					
Operating Temperature	-30 to +55°C (no freezing)					
Operating Humidity	45 to 85% RH (no condensation)					
Storage Temperature	-35 to +70°C (no freezing)					
Operating Atmosphere	No corrosive gases					
Life ²	40,000 hours (Ta = 25°C) (The total illumination life in which the brightness maintains a minimum of 70% of the initial value.)					
Degree of Protection	IP65 (IEC 60529)					
Material	Front Cover: Polycarbonate Resin; End Cover/Cable Gland: Polyamide Resin; Cable: PVC sheathing (24AWG)					
Weight (approx.)	100-240V AC	200g	255g	400g	520g	645g
	12V/24V DC	175g	235g	370g	-	-

1. 100V AC input for 100 - 240V AC; 12V DC input for 12V/24V DC.

2. LED life is dependent on the operating environment and conditions.

Part Numbers

Illumination Color	White			
	Clear Cover		White Cover	
Rated Voltage	100 - 240V AC		12V/24V DC	
LF2B-B (210mm)	LF2B-B3P-ATHWW2-1M	LF2B-B3P-BTHWW2-1M	LF2B-B4P-ATHWW2-1M	LF2B-B4P-BTHWW2-1M
LF2B-C (330mm)	LF2B-C3P-ATHWW2-1M	LF2B-C3P-BTHWW2-1M	LF2B-C4P-ATHWW2-1M	LF2B-C4P-BTHWW2-1M
LF2B-D (580mm)	LF2B-D3P-ATHWW2-1M	LF2B-D3P-BTHWW2-1M	LF2B-D4P-ATHWW2-1M	LF2B-D4P-BTHWW2-1M
LF2B-E (830mm)	LF2B-E3P-ATHWW2-1M		LF2B-E4P-ATHWW2-1M	
LF2B-F (1,080mm)	LF2B-F3P-ATHWW2-1M		LF2B-F4P-ATHWW2-1M	

Part Number Structure (use for interpreting part numbers only)

LF2B - C 3 P - ATHWW2 - 1M

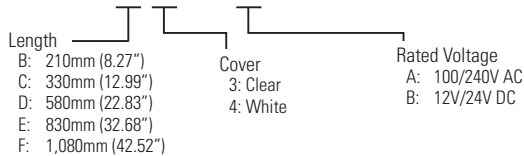

DC12V/24V Length: B (210mm), C (330mm), D (580mm) only

Dimensions (mm)

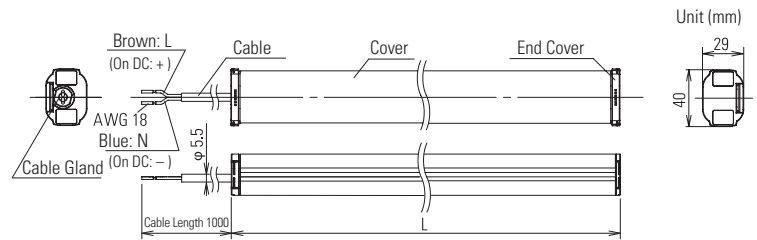

Dimension Table

Part Number	L (mm)	Inch
LF2B-B□P-◇THWW2-1M	210	8.27
LF2B-C□P-◇THWW2-1M	330	12.99
LF2B-D□P-◇THWW2-1M	580	22.83
LF2B-E□P-◇THWW2-1M	830	32.68
LF2B-F□P-◇THWW2-1M	1,080	42.52

Accessories

Item	Part Number	Remarks
Mounting Bracket (U-shape)	LF9Z-1SB21	Comes with the product (see Note below)
Mounting Bracket (L-shape)	LF9Z-1SB22	Order separately

LF2B-B and -C includes 2 brackets each; LF2B-E 3 brackets, and LF2B-F 4 brackets.

Illuminance Charts (Clear light at 0.5m)

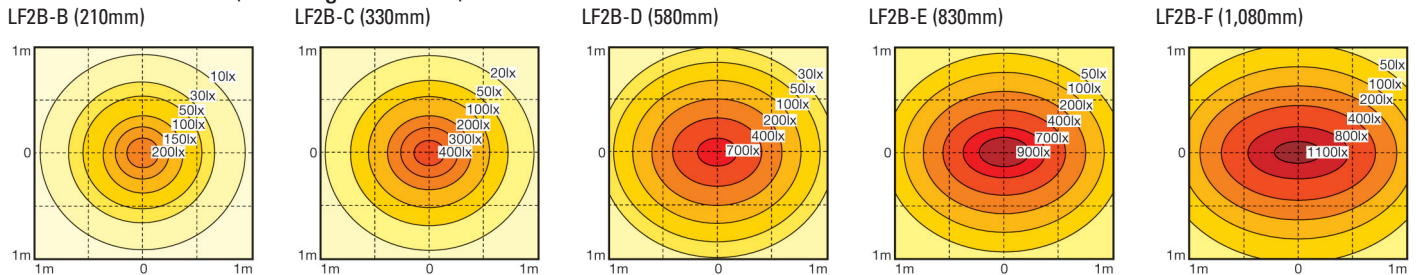

800.262.4332

www.IDEC.com/usa/LED

LUMIFA LF1B-N

Control Panels • Industrial Machines • Commercial Display Cases

LF1B-N Series

The LF1B-N series LED light strips are slim and perfect for applications where space is a concern. They come in six different lengths and six distinct colors, making them a very flexible lighting solution.

- Compact design: 27.5mm wide, 16mm high, and 134 to 1,080mm long
- 6 Colors: cool white, warm white, yellow, red, blue, green
- All units come standard with 3 meter connection cables
- 2 Cover options: clear, white
- IP65 degree of protection (waterproof, dustproof), suitable for use in wet locations



LED Optical Specifications

Illumination Color		Cool White		Warm White		Yellow		Red		Green		Blue	
Cover		Clear	White	Clear	White	Clear	White	Clear	White	Clear	White	Clear	White
Color Temperature/ Dominant Wavelength (typ.)		6,500K		2,900K		590nm		620nm		525nm		455nm	
Reference Brightness (typ.) at 0.5m	LF1B-NA	95lx	85lx	60lx	55lx	20lx	18lx	20lx	18lx	30lx	27lx	10lx	9lx
	LF1B-NB	240lx	215lx	145lx	130lx	40lx	36lx	40lx	36lx	60lx	55lx	20lx	18lx
	LF1B-NC	455lx	410lx	250lx	225lx	75lx	65lx	75lx	65lx	110lx	100lx	30lx	27lx
	LF1B-ND	840lx	750lx	455lx	410lx	125lx	110lx	125lx	110lx	190lx	170lx	50lx	45lx
	LF1B-NE	1100lx	995lx	560lx	500lx	160lx	145lx	160lx	145lx	260lx	235lx	60lx	55lx
	LF1B-NF	1350lx	1210lx	620lx	555lx	180lx	160lx	180lx	160lx	300lx	270lx	80lx	70lx

LED modules and illumination units may vary in illumination colors and brightness.

General Specifications

Model		LF1B-NA (134mm)	LF1B-NB (210mm)	LF1B-NC (330mm)	LF1B-ND (580mm)	LF1B-NE (830mm)	LF1B-NF (1,080mm)
Rated Voltage		24V DC (operating voltage range: 21.6 to 26.4V)					
Input Current (typ.) (at the rated current)	cool white/warm white/blue	60mA	120mA	180mA	360mA	540mA	720mA
	red/yellow/green	40mA	80mA	120mA	240mA	360mA	480mA
Power Consumption (typ.) (at the rated voltage)	cool white/warm white/blue	1.5W	2.9W	4.4W	8.7W	13.0W	17.3W
	red/yellow/green	1.0W	2.0W	2.9W	5.8W	8.7W	11.6W
Insulation Resistance		100MΩ minimum (500V DC megger)					
Dielectric Strength		1,000V AC, 1 minute (between live and dead parts)					
Vibration Resistance (damage limits)		Frequency: 5 to 55Hz, Amplitude 0.5mm Acceleration 60m/s ² (6G), 2 hours each in 3 axes				Frequency: 5 to 55Hz, Amplitude 0.17mm Acceleration 20m/s ² (2G), 2 hours each in 3 axes	
Shock Resistance (damage limits)		1,000m/s ² (100G), 5 shocks each in 6 axes				300m/s ² (30G), 5 shocks each in 6 axes	
Operating Temperature		-30 to +55°C (no freezing)					
Operating Humidity		45 to 85% RH (no condensation)					
Storage Temperature		-35 to +70°C (no freezing)					
Operating Atmosphere		No corrosive gases					
Life (Note)		40,000 hours (Ta = 25°C) (The total illumination life in which the brightness maintains a minimum of 70% of the initial value.)					
Degree of Protection		IP65 (IEC 60529)					
Material		Cover: polycarbonate, End cover/cable gland: polyamide, Wire: PVC (24AWG)					
Weight (approx.)		95g	125g	165g	255g	430g	740g

1. LED life depends on the operating environment.

Part Numbers

Illumination Color	Cool White	Warm White	Yellow	Red	Blue	Green
Appearance						
LF1B-NA (134mm)	LF1B-NA⊙P-2THWW2-3M	LF1B-NA⊙P-2TLWW2-3M	LF1B-NA⊙P-2SHY2-3M	LF1B-NA⊙P-2SHR2-3M	LF1B-NA⊙P-2THS2-3M	LF1B-NA⊙P-2SHG2-3M
LF1B-NB (210mm)	LF1B-NB⊙P-2THWW2-3M	LF1B-NB⊙P-2TLWW2-3M	LF1B-NB⊙P-2SHY2-3M	LF1B-NB⊙P-2SHR2-3M	LF1B-NB⊙P-2THS2-3M	LF1B-NB⊙P-2SHG2-3M
LF1B-NC (330mm)	LF1B-NC⊙P-2THWW2-3M	LF1B-NC⊙P-2TLWW2-3M	LF1B-NC⊙P-2SHY2-3M	LF1B-NC⊙P-2SHR2-3M	LF1B-NC⊙P-2THS2-3M	LF1B-NC⊙P-2SHG2-3M
LF1B-ND (580mm)	LF1B-ND⊙P-2THWW2-3M	LF1B-ND⊙P-2TLWW2-3M	LF1B-ND⊙P-2SHY2-3M	LF1B-ND⊙P-2SHR2-3M	LF1B-ND⊙P-2THS2-3M	LF1B-ND⊙P-2SHG2-3M
LF1B-NE (830mm)	LF1B-NE⊙P-2THWW2-3M	LF1B-NE⊙P-2TLWW2-3M	LF1B-NE⊙P-2SHY2-3M	LF1B-NE⊙P-2SHR2-3M	LF1B-NE⊙P-2THS2-3M	LF1B-NE⊙P-2SHG2-3M
LF1B-NF (1,080mm)	LF1B-NF⊙P-2THWW2-3M	LF1B-NF⊙P-2TLWW2-3M	LF1B-NF⊙P-2SHY2-3M	LF1B-NF⊙P-2SHR2-3M	LF1B-NF⊙P-2THS2-3M	LF1B-NF⊙P-2SHG2-3M

In place of ⊙ insert 3 for clear cover and 4 for white cover.

Part Number Structure (use for interpreting part numbers only)

LF1B - NC 3 P - 2 THWW2 - 3M

Length	Cover	Cable Length
A: 134mm (5.28")	3: Clear	3M: 3m
B: 210mm (8.27")	4: White	1M: 1m
C: 330mm (12.99")		
D: 580mm (22.83")	Illumination Color	
E: 830mm (32.68")	THWW2: Cool white	SHR2: Red
F: 1,080mm (42.52")	TLWW2: Warm white	THS2: Blue
	SHY2: Yellow	SHG2: Green

Dimensions (mm)

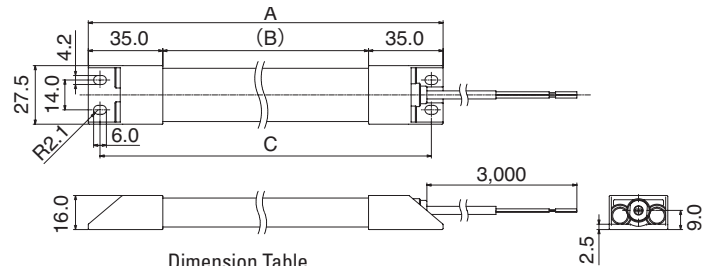

Dimension Table

Model	A		B		C	
	mm	inch	mm	inch	mm	inch
LF1B-NA	134	5.28	64	2.52	123	4.84
LF1B-NB	210	8.27	140	5.51	199	7.83
LF1B-NC	330	12.99	260	10.24	319	12.56
LF1B-ND	580	22.83	510	20.08	569	22.40
LF1B-NE	830	32.68	760	29.92	819	32.24
LF1B-NF	1080	42.52	1010	39.76	1069	42.09

Brilliance Distribution at 0.5m (reference value)

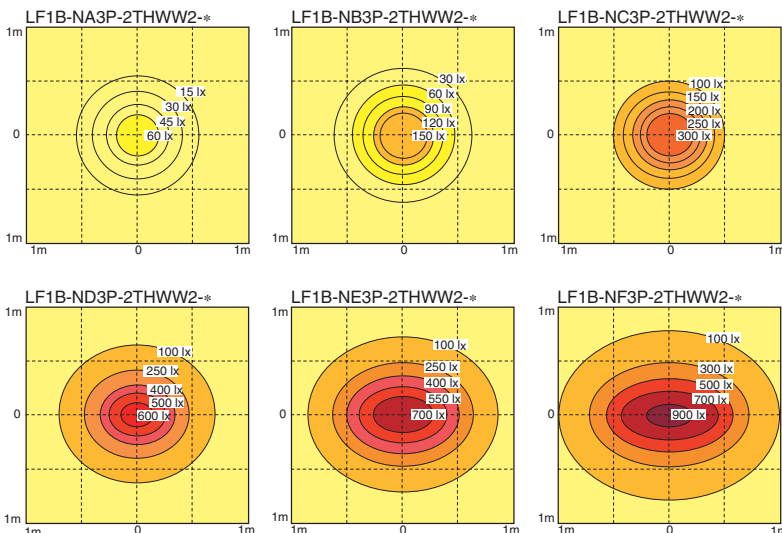

Accessory



Item	Mounting Bracket- Adjustable Angle
Part No.	LF9Z-1MB1
Material	Stainless Steel

- 1 pair, Left and Right.
- Not applicable to LF1B-ND.

LUMIFA LF1A

Control Panels • Manufacturing Equipment

LF1A Series

LF1A LED strips use super-bright multi-chip LEDs providing illumination equivalent to a 25W fluorescent lamp, while consuming only one-third the power. They come in a thin housing available in three sizes with four color configurations: cool white (5500K), warm white (2800K), yellow (590nm) and red (625nm).

- Brightness: 66.6 Lumens/Watt
- Energy savings: One-third of fluorescent lamps
- Long life: 40,000 hrs (Half-life)
- UL Listed
- RoHS Compliant
- IP40



LED Optical Specifications

Model	LF1A-*-2THWW6	LF1A-*-2TLWW6	LF1A-*-2SHY8	LF1A-*-2SHR8
Illumination Color	Cool White	Warm White	Yellow	Red
Luminous Intensity (Single LED module)	6,000mcd	4,000mcd	4,000mcd	2,500mcd
Color Temperature / Dominant Wavelength	5,500K	2,800K	590nm	625nm
Reference Illuminance at 0.5m	LED Array 3 x 2 190lx	LED Array 6 x 2 380lx	LED Array 12 x 2 760lx	LED Array 3 x 2 85lx
		LED Array 6 x 2 260lx	LED Array 12 x 2 520lx	LED Array 6 x 2 170lx
			LED Array 12 x 2 520lx	LED Array 12 x 2 340lx

*LED Array A1 = 3x2 , B1 = 6x2, D1 = 12x2

General Specifications





Model	LF1A-*-2THWW6	LF1A-*-2TLWW6	LF1A-*-2SHY8	LF1A-*-2SHR8
Rated Voltage	24V DC (non-polarized)			
Input Current (at rated voltage)	LED Array 3 x 2 75mA	LED Array 6 x 2 150mA	LED Array 12 x 2 300mA	90mA 180mA 360mA
Rated Power (at rated voltage)	LED Array 3 x 2 1.8W	LED Array 6 x 2 3.6W	LED Array 12 x 2 7.2W	2.2W 4.4W 8.7W
Dielectric Strength	Between live and dead parts: 1000V AC, 1 minute			
Insulation Resistance	Between live and dead parts: 100 MΩ (500V DC megger)			
Operating Temperature	-20 to +50°C			
Storage Temperature	-25 to +70°C			
Operating/Storage Humidity	45 to 85% RH (no condensation)			
Life (half luminance) ²	40,000 hours			
Weight (approx.)	LF1A-A1: 190g, LF1A-B1: 270g, LF1A-D1: 470g			
Degree of Protection	IP40			

1. *LED Array A1 = 3x2 , B1 = 6x2, D1 = 12x2
2. LED life depends upon operating environment.

800.262.4332

www.IDEC.com/usa/LED

Part Numbers

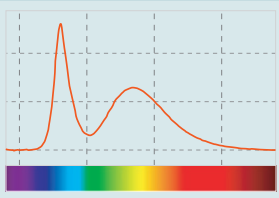
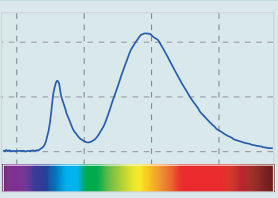
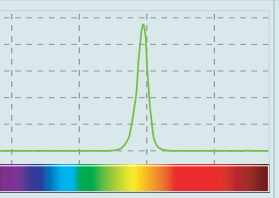
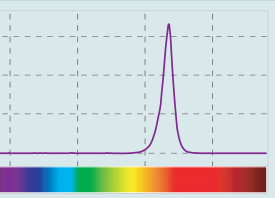
Color	Cool White	Warm White	Yellow	Red
Part No.	LF1A-*-2THWW6	LF1A-*-2TLWW6	LF1A-*-2SHY8	LF1A-*-2SHR8
Appearance				
Light Spectrum				

*LED Array A1 = 3x2 , B1 = 6x2, D1 = 12x2

Part Number Structure (use for interpreting part numbers only)

LF1A – A1 – 2 THWW6

LED Module Arrangement
 A1: 3 LEDs × 2 rows
 B1: 6 LEDs × 2 rows
 D1: 12 LEDs × 2 rows

LED Illumination Color
 THWW6: Cool White
 TLWW6: Warm white
 SHY8: Yellow
 SHR8: Red

Light Distribution at 0.5m LF1A-D1-THWW6 (Cool White)

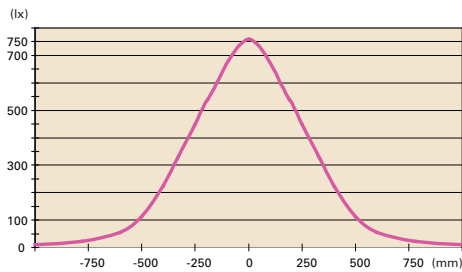

Illuminance Chart LF1A-D1-2THWW6

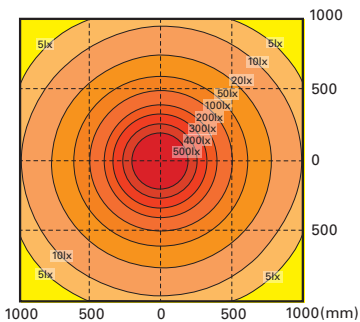

Dimensions (mm)

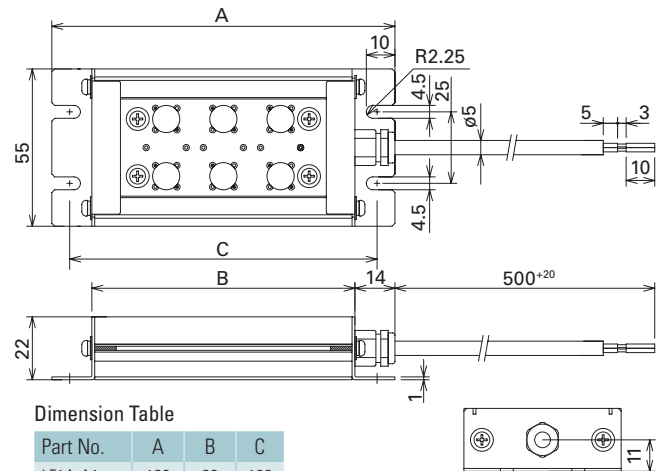

Dimension Table

Part No.	A	B	C
LF1A-A1-	120	92	108
LF1A-B1-	180	152	168
LF1A-D1-	300	272	288

Accessory



Item	Mounting Bracket- Adjustable Angle
Part No.	LF9Z-1MA1
Material	Stainless Steel

1 pair, Left and Right

LUMIFA EF1A

Hazardous and Wet Locations

EF1A Series

Hazardous locations LED illumination units, EF1A are ideal for locations that require additional protection. With an IP67 rating, they can be used in wet locations subject to high-pressure spray.

- Hazardous locations LED units (Class 1, Zone 1 and Zone 2)
- Slim or wide models available
- 2 cover colors: clear or white
- Available with adjustable, fixed angle or no mounting bracket
- IP67 (without switch)
- IP65 (with switch)



LED Optical Specifications

Model	EF1A			
	Clear		Diffused	
Collecting Lens (Light Distribution)	With	Without	With	Without
Illumination Color	White			
Color Temperature (typ.)	5700K			
Total Luminous Flux (typ.)	960lm			
Reference Illuminance (typ.) At 1.0m directory below	1100lx	205lx	450lx	175lx

800.262.4332

www.IDEC.com/usa/LED

General Specifications

Model	EF1A -11	EF1A -12
Explosion protection	Ex d II C T4	
Zone	Zone 1, Zone 2	
Rated voltage	24V DC	100 to 240V AC
Voltage Range	18 to 26.4V DC	90 to 264V AC
Rated Power (Typ.)	17W (at rated voltage)	19W (at rated voltage)
Insulation Resistance	50MΩ minimum (500V DC megger) input - FG	100MΩ minimum (500V DC megger) input - FG
Dielectric Strength	500V AC 1 minute input - FG	2000V AC 1 minute input - FG
Vibration Resistance (damage limits)	Frequency 5 to 55Hz, amplitude 0.5mm	
Shock Resistance (damage limits)	1000m/s ²	
Operating Temperature	-20 to +50°C (no freezing)	
Operating Humidity	45 to 85% RH (no condensation)	
Storage Temperature	-35 to +70°C (no freezing)	
Life ¹	50,000 hours (The illumination duration in which the brightness maintains a minimum of 70% of initial value at 25°C)	
Degree of Protection	IP67 (IEC 60529), IP65 (with pushbutton switch)	
Material	Housing: aluminum, front panel: stainless steel, mounting bracket: stainless steel Illumination surface: reinforced glass, cable gland: nickel-plated brass	
Weight (approx.)	3.2Kg (without mounting bracket), 3.4Kg (with mounting bracket)	

1. LED life depends upon operating environment.

Part Numbers

Light Distribution	Mounting Bracket	Waterproof Cable Clamp	Illumination Surface ①	Terminal Block ②	Cable Gland Outer Diameter ③	Part No.
Narrow	Without (4-M6 screw on the back of EF1A)	With Without	Blank: Clear 1: Diffused	Blank: Spring Clamp Terminal S: Screw Terminal C: Lead Wire	10: ø8-ø10 12: ø10-ø12 14: ø12-ø14 16: ø14-ø16	EF1A-1⑥1W④2-③⑤
	With (Fixed angle)	With Without				EF1A-1⑥1W④2A-③⑤
	With (Adjustable angle)	With Without				EF1A-1⑥1W④2B-③⑤
Wide	Without (4-M6 screw on the back of EF1A)	With Without				EF1A-1⑥1W1④2-③⑤
	With (Fixed angle)	With Without				EF1A-1⑥1W1④2A-③⑤
	With (Adjustable angle)	With Without				EF1A-1⑥1W1④2B-③⑤

In place of ① insert Illumination Surface code, in place of ② insert Cable Wiring code, in place of ③ insert Cable Outer Diameter code, in place of ④ insert Cable Gland/Switch code, in place of ⑤ insert Pushbutton Switch code and in place of ⑥ insert the Voltage code.

Part Number Structure (use for interpreting part numbers only)

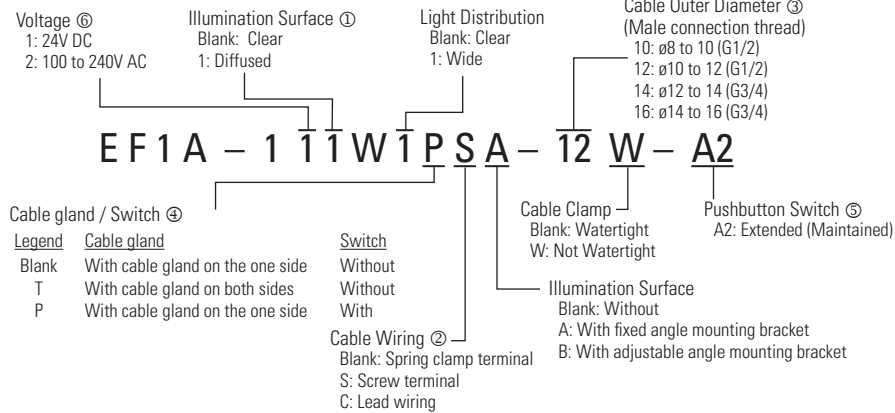

Dimensions (mm) without mounting bracket

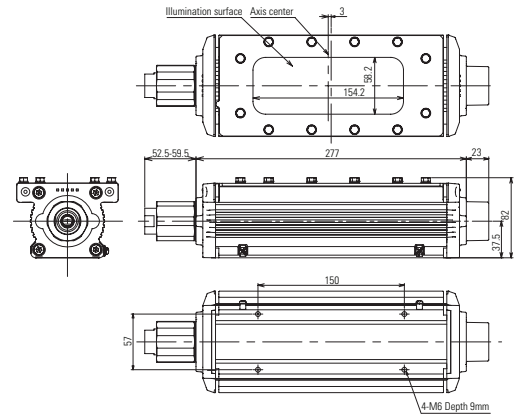

Light Distribution (cd/1000lm)

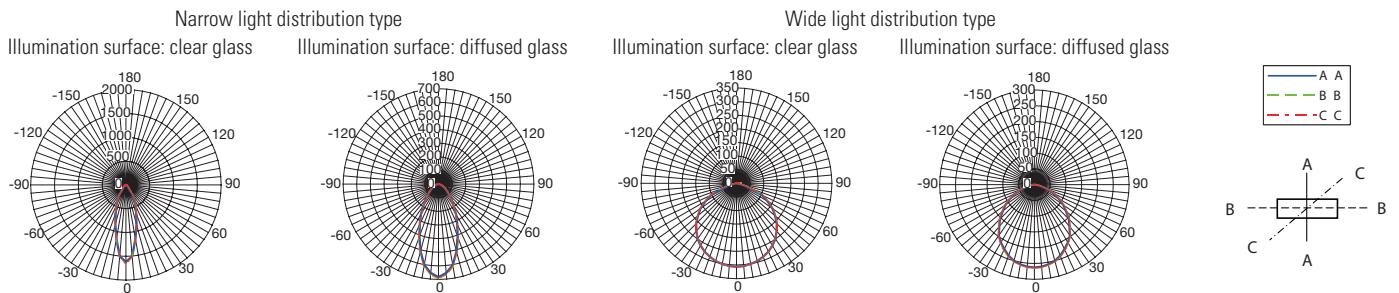

Illuminance Distribution (at 1.0m)

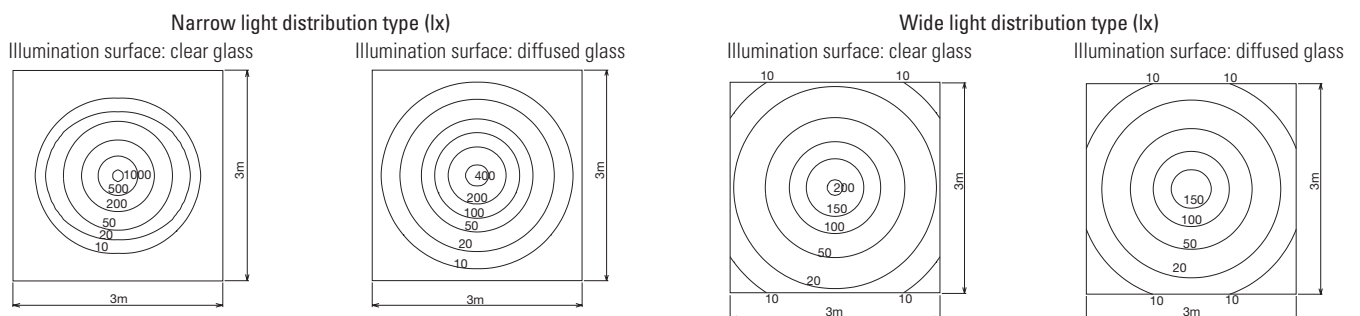

LUMIFA LF1F

Visual Inspection Lighting • Elevator Ceiling Lighting

LF1F Series

Unlike fluorescent lights, LED lights do not flicker and therefore illuminate objects evenly. Uneven surfaces, such as scratches and flaws, are more visible providing more accurate inspections. The LF1F provides steady light regardless of ambient temperature and the narrow profile saves space allowing mounting flexibility.

- Energy saving
- Long operating life
- Maintenance free
- 12mm-thin bezel saves space
- 300mm square illuminated surface
- Wider operating temperature range than fluorescent lighting

LED Optical Specifications

Model	LF1F
Color Temperature	8,500K
Reference Illuminance at 1.0m	5,800lx minimum (panel center)

Operating Specifications

Model	LF1F
Operating Voltage Range	21.6 ~ 26.4V DC
Wattage (typ.)	11W
Insulation Resistance	100MΩ minimum
Dielectric Strength	1,000V, 50/60Hz, 1 minute
Vibration Resistance	5 ~ 55Hz, amplitude 0.5mm, 60m/s ² (3 directions, 2 hours each)
Shock Resistance	1,000m/s ²
Operating Temperature	-10° ~ 60 (no freezing)
Operating Humidity	45 ~ 85% RH (no condensation)
Storage Temperature	-20° ~ 70°C (no freezing)
Operating Environment	No corrosive gases, no harmful dust
Life ¹	40,000 hours
Degree of Protection	IP20 (IEC60529)
Materials	Housing: Aluminum Light emitting part: acrylic; Cover: acrylic
Weight (approx.)	1.1kg

1. LED life depends upon operating environment.

Part Numbers

Appearance	Model	Cable Length	Size	Color Temperature
	LF1F-B4-2D1	1m	300mm square	8,500K
	LF1F-B4-2D3	3m		

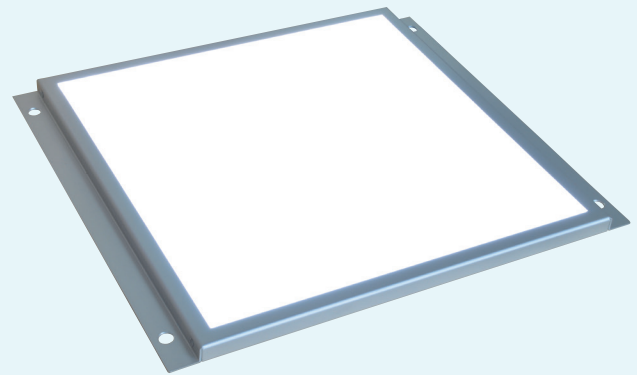

Applications

Ideal for visual inspection, as the LF1F makes it easy to see even the slightest surface flaws.



Application examples for product inspections

- Detect uneven plastic and rubber part surfaces
- Detect dust on glass or plastic plates
- Illuminate marks on metal surfaces during cutting and marking
- Detect flaws on painted or plated surfaces
- Detect scratches and unevenness on embossed materials
- Detect scratches and foreign materials on silicon wafers
- Elevator illumination

Dimensions (mm)

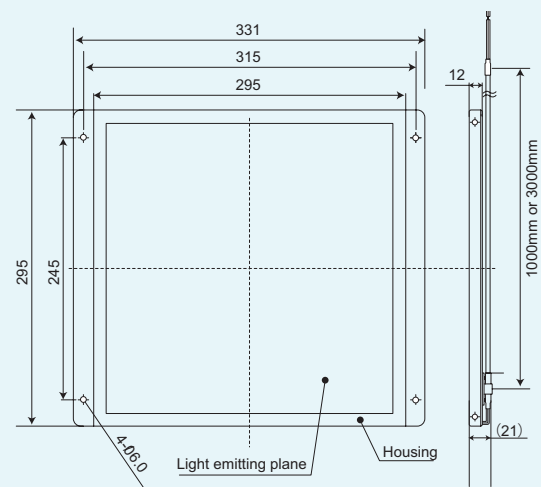

(Light emitting plane: 271 x 271)

800.262.4332

www.IDEC.com/usa/LED

LED Signallight Towers - LD6A

Unique Striped Design Improves Visibility

Looking for a safe and reliable way to instantly see the status of a machine or a process? The LD6A Signallight Tower's innovative striped design with non-illuminated area between the lenses, and the oval lens shape provide high-visibility from different directions. With five different mounting styles, flashing and audible alarm options and with a protection rating up to IP65, there is an LD6A that will fit your signaling needs.



Support Information

IDEC LED Illumination
www.IDEC.com/usa/LED

Technical Support
support@IDEC.com

800-262-IDECC
www.IDEC.com/usa

800.262.4332



Think Automation and beyond...

www.IDEC.com

USA

IDECC Corporation
Tel: (408) 747-0550
opencontact@IDEC.com

Canada

Tel: (905) 890-8561
sales@ca.IDEC.com

Australia

IDECC Australia Pty. Ltd.
Tel: +61-3-8523-5900
sales@au.IDEC.com

Japan

IDECC Corporation
Tel: +81-6-6398-2571
marketing@IDEC.co.jp

United Kingdom

IDECC Electronics Ltd.
Tel: +44-1256-321000
sales@uk.IDEC.com

Germany

IDECC Elektrotechnik GmbH
Tel: +49-40-253054-0
service@IDEC.de

Hong Kong

IDECC (H.K.) Co., Ltd.
Tel: +852-2803-8989
info@hk.IDEC.com

China/Beijing

IDECC (Beijing) Corporation
Tel: +86-10-6581-6131

China/Shanghai

IDECC (Shanghai) Corporation
Tel: +86-21-6135-1515
idec@cn.IDEC.com

China/Shenzhen

IDECC (Shenzhen) Corporation
Tel: +86-755-8356-2977

Singapore

IDECC Asia Pte. Ltd.
Tel: +65-6746-1155
info@sg.IDEC.com

Taiwan

IDECC Taiwan Corporation
Tel: +886-2-2698-3929
service@tw.IDEC.com

©2016 IDECC Corporation. All Rights Reserved.
Catalog No. LF9Y-B100-3a 2/16 pdf only

Specifications and other descriptions in this catalog are subject to change without notice.

1602291437