



*Think Automation and beyond...*



***IDEC Power Supplies***  
***Setting a New Standard***



# Experience the Revolution

Power supplies that adapt to your application

## Setting a new standard

Utilizing the latest advancements in technology, our new expandable line of PS6R power supplies are the first in the industry with DC-DC converters that provide multiple voltage outputs from one unit! Able to meet the ever-changing demands of your application, these power supplies combine big power in a small package, providing space savings and less wiring time. The bottom line is a cost effective solution with the flexibility to adapt to your changing power requirements as your application evolves!

As a leader in the industry, our engineers continuously research new and better solutions to increase the efficiency and safety of our products. At IDEC, power supplies aren't just an "add-on" product; they are the foundation of a reliable application. We are committed to upholding the highest standards of manufacturing and design to produce a complete line of power supplies that outlast and outperform the competition!

## IDEC's History of Innovation

- 1st with UL 508 approval
- 1st with finger-safe screw terminals
- 1st with SEMI F47 approval
- 1st expandable DIN rail power supply



# PS6R: World's First Expandable Power Supply

## Universal Inputs

The power inputs have a range of 85-264V AC to 110-350V DC, and automatically adjust to the correct input power.

## Alarm Output

NPN transistor output can be used to signal when output voltage is below 80% of rated value.

## Add-on Expansion Modules

When multiple output voltages or extra wiring terminals are needed, choose from seven expansion modules instead of buying another power supply.

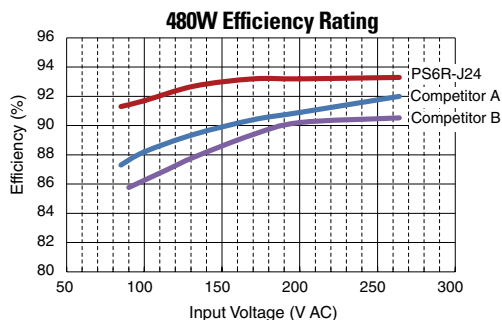
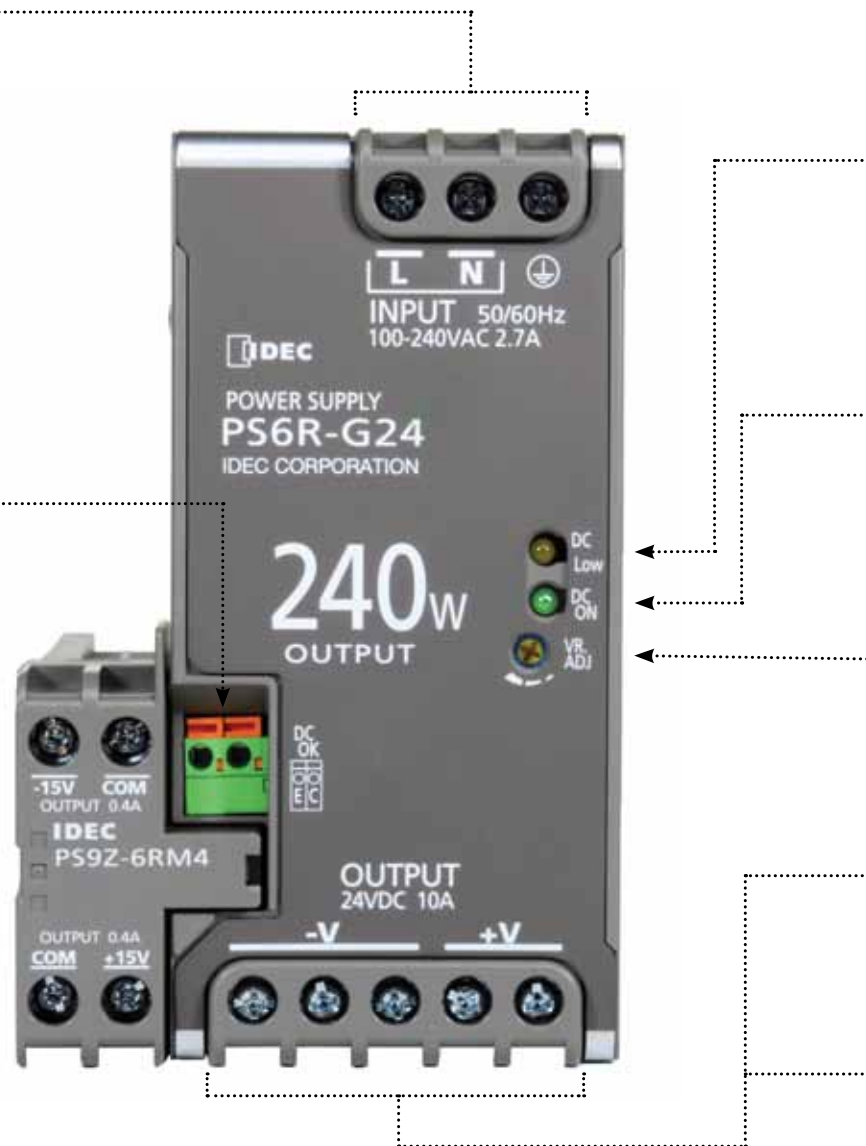

With a 93 percent efficiency rating, PS6R power supplies save energy while maintaining high output ratings and improving productivity. Saving energy at the component level drives energy savings throughout your application. Plus these power supplies generate less heat in the cabinet, reducing temperature stress on critical components.

..... **DC Low Indicator**

Indicator turns on when the output voltage drops below 80% of the rated value.

..... **DC ON Indicator**

Indicator turns on when the unit is powered up.

..... **Output Voltage Adjustment**

The output voltage can be easily adjusted within +/- 10% of the rated voltage.

..... **Output Channel**

PS6R power supplies have very low output ripples of less than 1% peak to peak.

..... **Spring-up, Finger-safe Screw Terminals**

These terminals provide additional safety, increase ease of use, and allow use of ring or fork terminals.



## Need to conserve space?

These highly-efficient power supplies are significantly smaller and slimmer than other similar wattage power supplies on the market today. Available with a DC-DC converter allowing up to three separate voltages to be used simultaneously, PS6R power supplies are ideal for industrial applications where panel space is limited.

### Conventional Power Supplies



### PS6R with Expansion module

A branch terminal module can also be added to reduce the amount of space needed for wiring and installation by providing additional wiring terminals.

#### Using Terminal Blocks



#### Using Branch Terminal Unit



800.262.4332

www.IDEC.com/powersupply

## The Right Power Supply For Your Application



### PS6R Expandable

- Expansion modules add flexibility
- 5V, 12V & 15V attachments
- 24V DC main output
- Adjustable output voltage
- Slim and compact
- DIN rail or direct mounting
- 93% efficiency
- Finger-safe screw terminals
- Output alarm contact
- Class I, Div. 2, SEMI F47, UL508



### PS5R-S Slim

- Slim and compact
- DIN rail or direct mounting
- Finger-safe screw terminals
- 5V, 12V and 24V outputs
- Adjustable output voltage
- Class I, Div. 2, SEMI F47, UL508



### PS5R Standard

- Wide power range: 7.5W - 480W
- Single- and three-phase versions
- DIN rail or direct mounting
- Finger-safe screw terminals
- 5V, 12V and 24V outputs
- Adjustable output voltage
- UL 508



### PS3X Metal

- Compact and cost-effective
- Five output wattages
- 5V, 12V and 24V outputs
- DIN rail or direct mounting
- Finger-safe screw terminals
- UL/c-UL recognized and CE marked

800.262.4332

www.IDEC.com/powersupply

## Four models to choose from

Your power supply is a critical part of your system. So when it comes to choosing a power supply, it's important to find the right one. With four distinct series, IDEC has power supplies to fit a variety of applications. Whether you need a power supply that can grow with your application, fit in a tight space, provide a wide power range or meet a fixed budget, IDEC provides the best options to meet your specific power needs!

	PS6R	PS5R-S	PS5R	PS3X
Universal input voltage allows use around the world	✓	✓	✓	✓
RoHS compliant	✓	✓	✓	✓
Finger-safe terminals for worker safety	✓	✓	✓	✓
Adjustable output voltage	✓	✓	✓	✓
Operation indicator LED	✓	✓	✓	✓
Series wiring capable for extra output voltage	✓	✓	✓	✓
DIN Rail mount	✓	✓	✓	✓
Panel mount	✓	✓	✓	✓
UL 508	✓	✓	✓	
High stability with output hold time = 20ms	✓	✓	✓	
Power factor correction	✓	✓	✓	
Spring-up screw terminals accept ring lugs, fork connectors, or stripped wire	✓	✓	✓	
Parallel capable for extra output current	✓		✓	
Output voltage low LED	✓	✓		
Class I, Division 2 for use in hazardous locations	✓	✓		
SEMI F47 sag immunity	✓	✓		
Slim, space saving design	✓	✓		
3-phase operation			✓	
Low profile design for shallow cabinets			✓	
Voltage expansion modules	✓			
Additional wiring terminals	✓			
Alarm output contact	✓			
High efficiency greater than 90%	✓			
High operating temperature of 70°C	✓			

# PS6R Power Supplies



## Expandable Series

- Expansion modules for multiple voltages
- Lightweight and compact in size
- Wide power range:  
120W - 480W
- Universal input:  
85-264V AC/110-350V DC
- Power Factor Correction
- Meets SEMI F47 Sag Immunity
- Approved for Class I Div. 2 Hazardous Locations
- Overcurrent protection, auto-reset
- Overvoltage protection, shut down
- Spring-up Screw Terminal type, IP20 (finger-safe)
- DIN rail or panel surface mount
- Approvals:
  - CE Marked
  - TÜV
  - c-UL, UL508
  - CSA C22.2 No. 107.1
  - UL1604: Class I Div 2
  - EN 50178
  - LVD: EN60950
  - EMC: Directive EN61204-3
  - EMI: Class B, EMS: Industrial



### 120-Watt Power Supply

Part Number	Rated Voltage	Rated Current
PS6R-F24	24V DC	5A



### 240-Watt Power Supply

Part Number	Rated Voltage	Rated Current
PS6R-G24	24V DC	10A



### 480-Watt Power Supply

Part Number	Rated Voltage	Rated Current
PS6R-J24	24V DC	20A

## Expansion made easy



By attaching an expansion module, you can easily configure the PS6R to your custom requirements. DC-DC converters allow up to three separate voltages to be used simultaneously, while a branch terminal module provides additional wiring terminals. Plus the flexibility of PS6R means you can adapt the power supply to your changing requirements, without additional investment in engineering or wiring.



## Expansion Modules

### DC-DC Converter Module



Part Number	Output
PS9Z-6RM1	+5V, 2A, 10W
PS9Z-6RM2	+12V, 1A, 12W
PS9Z-6RM3	+5V, 1A/-5V, 1A 10W
PS9Z-6RM4	+15V, 0.4A/-15V, 0.4A, 12W
PS9Z-6RM5	+5V, 1A/+12V, 0.5A, 11W
PS9Z-6RM6	+12V, 0.5A/-12V, 0.5A, 12W



### Branch Terminal Module

Part Number	Rated Voltage/Current
PS9Z-6RS1	+24V/10A Max

800.262.4332

[www.IDEC.com/powersupply](http://www.IDEC.com/powersupply)



## Expandable Power Supply Dimensions

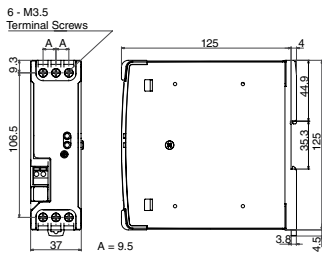

**PS6R-F24 (120W)**  
 Height 125mm  
 Width 37mm  
 Depth 125mm

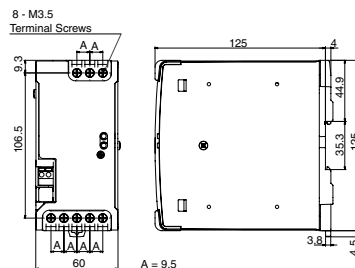

**PS6R-G24 (240W)**  
 Height 125mm  
 Width 60mm  
 Depth 125mm

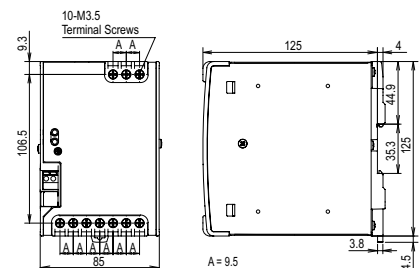

**PS6R-J24**  
 Height 125mm  
 Width 85mm  
 Depth 125mm

# PS5R Slim Line Power Supplies



## Slim Line Series

- Lightweight and compact in size
- Wide power range:  
10W-240W
- Universal input:  
10W to 90W: 85-264V AC/100-370V DC  
120W and 240W: 85-264V AC/100-350V DC
- Power Factor Correction for 60W to 240W:  
EN61000-3-2
- Meets SEMI F47 Sag Immunity (120W & 240W only)
- Approved for Class I Div. 2 Hazardous Locations
- Overcurrent protection, auto-reset
- Overvoltage protection, shut down
- Spring-up Screw Terminal type, IP20 (finger-safe)
- DIN rail or panel surface mount
- Approvals:  
CE Marked  
TÜV  
c-UL, UL508  
UL1310 (PS5R-SB, -SC, -SD)  
UL1604: Class I Div 2  
EN 50178  
LVD: EN60950  
EMC: Directive EN61204-3:2000  
EMI: Class B, EMS: Industrial



### 10-Watt/15-Watt Power Supply

Part Number	Rated Voltage	Rated Current
*PS5R-SB05	5V DC	2.0A
PS5R-SB12	12V DC	1.2A
PS5R-SB24	24V DC	0.65A

\*Total output: 10W



### 30-Watt Power Supply

Part Number	Rated Voltage	Rated Current
PS5R-SC12	12V DC	2.5A
PS5R-SC24	24V DC	1.3A



### 60-Watt Power Supply

Part Number	Rated Voltage	Rated Current
PS5R-SD24	24V DC	2.5A



### 90-Watt Power Supply

Part Number	Rated Voltage	Rated Current
PS5R-SE24	24V DC	3.75A



### 120-Watt Power Supply

Part Number	Rated Voltage	Rated Current
PS5R-SF24	24V DC	5A



### 240-Watt Power Supply

Part Number	Rated Voltage	Rated Current
PS5R-SG24	24V DC	10A



### Slim Line Dimensions

**PS5R-SB05 (10W)**  
**PS5R-SB12/SB24 (15W)**  
 Height 90mm  
 Width 22.5mm  
 Depth 95mm

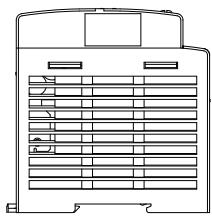
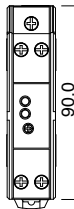

**PS5R-SC12/SC24 (30W)**  
**PS5R-SD24 (60W)**  
 Height 95mm  
 Width 36mm  
 Depth 108mm

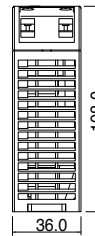
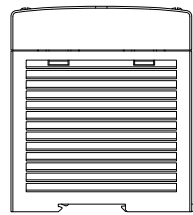
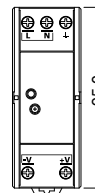

**PS5R-SE24 (90W)**  
 Height 115mm  
 Width 46mm  
 Depth 121mm

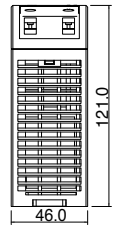
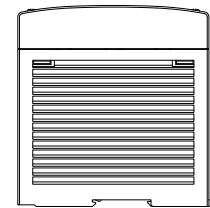
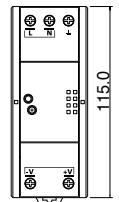

**PS5R-SF24 (120W)**  
 Height 115mm  
 Width 50mm  
 Depth 129mm

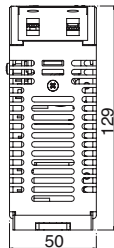
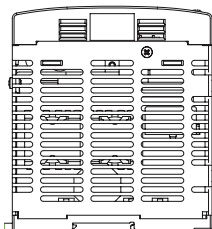
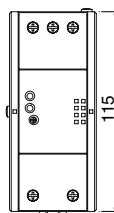

**PS5R-SG24 (240W)**  
 Height 125mm  
 Width 80mm  
 Depth 149.5mm

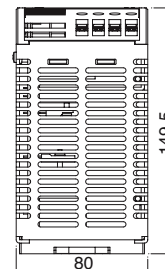
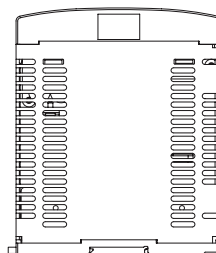
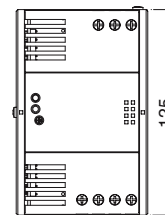

800.262.4332  
[www.IDEC.com/powersupply](http://www.IDEC.com/powersupply)

# PS5R Standard Power Supplies



## Standard Series

- Wide power range:  
7.5W-480W
- Universal input :  
7.5W-50W: 85-264V AC/105-370V DC  
100W: 85-132V AC/170-264V AC  
240-370V DC (selectable)  
75W, 120W, 240W: 85-264V AC/110-350V AC  
480W: 3-Phase 320-575V AC  
480W: 2-Phase 360-575V AC
- Overcurrent/overvoltage protection
- Power Factor Correction (75W, 120W, 240W models):  
EN61000-3-3  
EN61000-3-2
- Voltage adjustment  $\pm 10\%$
- Spring-up Screw Terminal, IP20 (finger-safe)
- DIN rail or panel surface mount
- Approvals:  
CE marked  
UL 508 Listed  
UL, c-UL  
TÜV approved
- EMC Directives:  
EN50081-2  
EN50082-2  
EN61000-6-2  
LVD EN60950:2000



### 7.5-Watt Power Supply

Part Number	Rated Voltage	Rated Current
PS5R-A05	5V DC	1.5A
PS5R-A12	12V DC	0.6A
PS5R-A24	24V DC	0.3A



### 15-Watt Power Supply

Part Number	Rated Voltage	Rated Current
*PS5R-B05	5V DC	2.5A
PS5R-B12	12V DC	1.2A
PS5R-B24	24V DC	0.6A

\*Total output: 12.5W



### 30-Watt Power Supply

Part Number	Rated Voltage	Rated Current
PS5R-C12	12V DC	2.5A
PS5R-C24	24V DC	1.3A



### 50-Watt Power Supply

Part Number	Rated Voltage	Rated Current
PS5R-D24	24V DC	2.1A



### 75-Watt Power Supply

Part Number	Rated Voltage	Rated Current
PS5R-Q24	24V DC	3.1A



### 100-Watt Power Supply

Part Number	Rated Voltage	Rated Current
PS5R-E24	24V DC	4.2A



### 120-Watt Power Supply

Part Number	Rated Voltage	Rated Current
PS5R-F24	24V DC	5A



### 240-Watt Power Supply

Part Number	Rated Voltage	Rated Current
PS5R-G24	24V DC	10A



### 480-Watt 3-Phase Power Supply

Part Number	Rated Voltage	Rated Current
PS5R-TJ24	24V DC	20A



## Standard Power Supply Dimensions

#### PS5R-A (7.5W)

Height 75mm  
Width 45mm  
Depth 70mm

#### PS5R-B (15W)

Height 75mm  
Width 45mm  
Depth 95mm

#### PS5R-C (30W)

Height 75mm  
Width 90mm  
Depth 95mm

#### PS5R-D (50W)

Height 75mm  
Width 90mm  
Depth 95mm

#### PS5R-Q (75W)

Height 120mm  
Width 85mm  
Depth 140mm

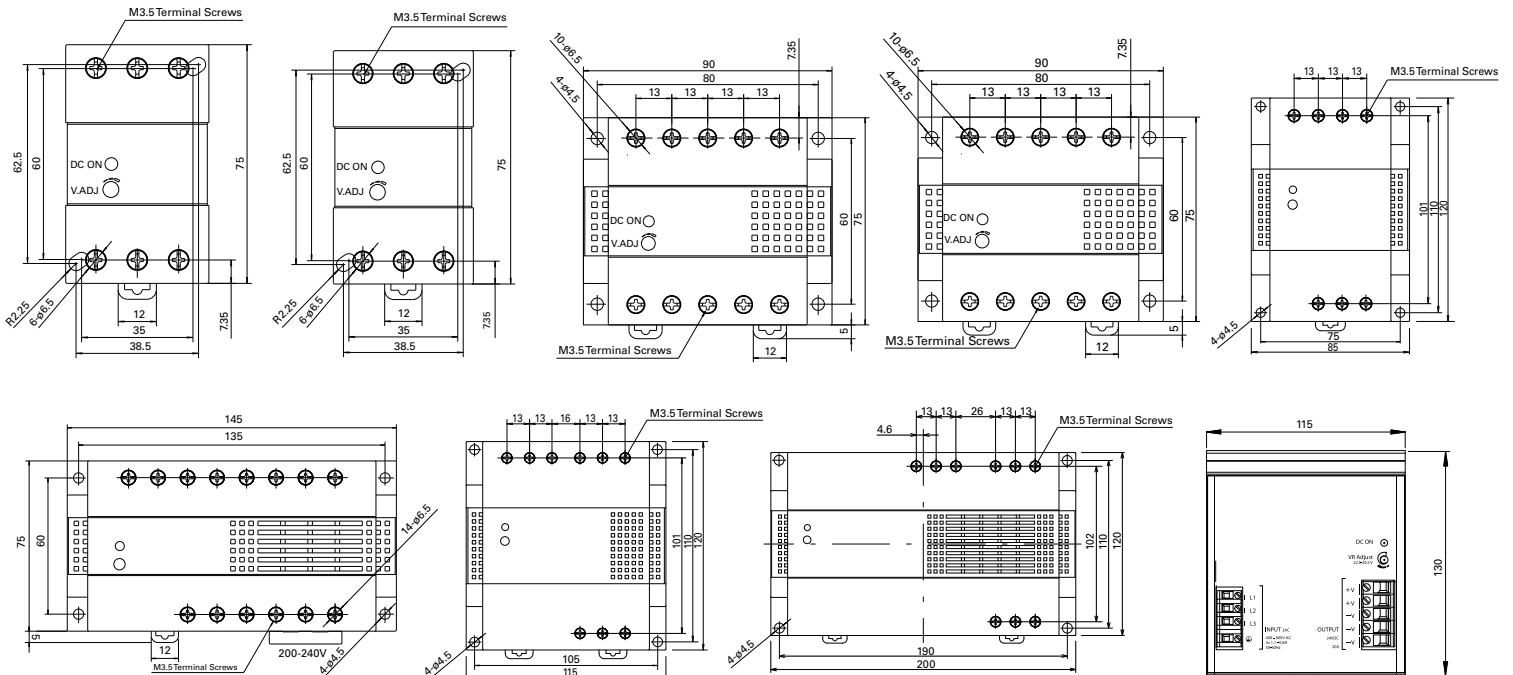

#### PS5R-E (100W)

Height 75mm  
Width 145mm  
Depth 95mm

#### PS5R-F (120W)

Height 120mm  
Width 115mm  
Depth 140mm

#### PS5R-G (240W)

Height 120mm  
Width 200mm  
Depth 140mm

#### PS5R-TJ24 (480W)

Height 130mm  
Width 115mm  
Depth 152.5mm

# PS3X Metal Power Supplies



## Metal Series

- Slim and compact style
- Wide Power Range:  
15W-100W
- Universal input:  
15W: 85-264V AC/120-375V DC  
25-100W: 88-264V AC/125-375V DC
- Overcurrent/Overvoltage protection
- Voltage  $\pm 10\%$  adjustment
- DIN-rail or panel-surface mounting brackets available
- Approvals:  
CE marked  
cURus  
EN60950-1 compliant
- EMC Directives:  
EN55022 Class B  
EN55024



### 15-Watt Power Supply

Part Number	Rated Voltage	Rated Current
PS3X-B05	5V DC	3A
PS3X-B12	12V DC	1.3A
PS3X-B24	24V DC	0.63A



### 25-Watt Power Supply

Part Number	Rated Voltage	Rated Current
PS3X-C05	5V DC	5A
PS3X-C12	12V DC	2.1A
PS3X-C24	24V DC	1.1A



### 50-Watt Power Supply

Part Number	Rated Voltage	Rated Current
PS3X-D12	12V DC	4.2A
PS3X-D24	24V DC	2.2A



### 75-Watt Power Supply

Part Number	Rated Voltage	Rated Current
PS3X-Q05	5V DC	12A
PS3X-Q12	12V DC	6A
PS3X-Q24	24V DC	3.2A



### 100-Watt Power Supply

Part Number	Rated Voltage	Rated Current
PS3X-E05	5V DC	16A
PS3X-E12	12V DC	8.5A
PS3X-E24	24V DC	4.5A

## Metal Power Supply Dimensions

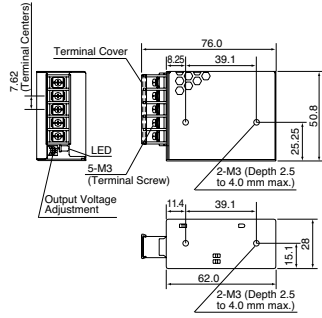

### PS3X-B (15W)

Height 50.8mm  
Width 28mm  
Depth 62mm

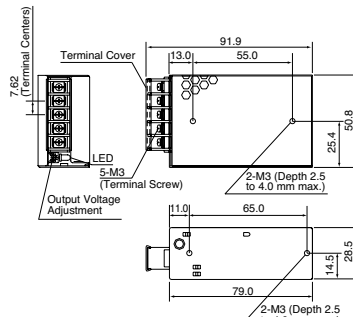

### PS3X-C (25W)

Height 50.8mm  
Width 28.5mm  
Depth 79mm

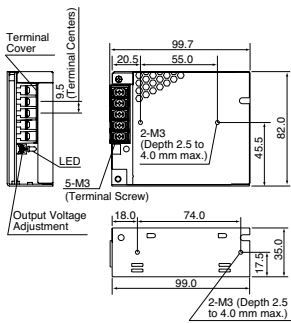

### PS3X-D (50W)

Height 82mm  
Width 35mm  
Depth 99mm

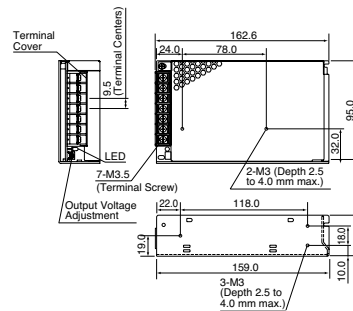

### PS3X-Q (75W)

Height 95mm  
Width 38mm  
Depth 129mm

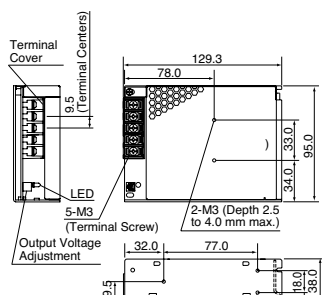

### PS3X-E (100W)

Height 95mm  
Width 38mm  
Depth 159mm

800.262.4332

[www.IDEC.com/powersupply](http://www.IDEC.com/powersupply)



# Your Single Source Solution

For more than 65 years, IDEC has focused on creating high-quality and reliable control and automation products, while giving you personalized service and customized solutions to keep your applications up and running.



Power supplies



Relays



HMIs



PLCs

800.262.4332

[www.IDEC.com/usa](http://www.IDEC.com/usa)



*Think Automation and beyond...*

## Technical support:

[support@idec.com](mailto:support@idec.com)

## Sales support:

[sales@idec.com](mailto:sales@idec.com)

[www.IDEC.com](http://www.IDEC.com)

### USA

**IDEC Corporation**  
Tel: (408) 747-0550  
[opencontact@idec.com](mailto:opencontact@idec.com)

### Canada

**IDEC Canada Ltd.**  
Tel: (905) 890-8561  
[sales@ca.IDEC.com](mailto:sales@ca.IDEC.com)

### Australia

**IDEC Australia Pty. Ltd.**  
Tel: +61-3-8523-5900  
[sales@au.IDEC.com](mailto:sales@au.IDEC.com)

### Japan

**IDEC Corporation**  
Tel: +81-6-6398-2527  
[marketing@idec.co.jp](mailto:marketing@idec.co.jp)

### United Kingdom

**IDEC Electronics Ltd.**  
Tel: +44-1256-321000  
[sales@uk.IDEC.com](mailto:sales@uk.IDEC.com)

### Germany

**IDEC Elektrotechnik GmbH**  
Tel: +49-40-253054-0  
[service@idec.de](mailto:service@idec.de)

### Hong Kong

**IDEC (H.K.) Co., Ltd.**  
Tel: +852-2803-8989  
[info@hk.IDEC.com](mailto:info@hk.IDEC.com)

### China/Beijing

**IDEC (Beijing) Corporation**  
Tel: +86-10-6581-6131

### China/Shanghai

**IDEC (Shanghai) Corporation**  
Tel: +86-21-6135-1515  
[idec@cn.IDEC.com](mailto:idec@cn.IDEC.com)

### China/Shenzhen

**IDEC (Shenzhen) Corporation**  
Tel: +86-755-8356-2977

### Singapore

**IDEC Asia Pte. Ltd.**  
Tel: +65-6746-1155  
[info@sg.IDEC.com](mailto:info@sg.IDEC.com)

### Taiwan

**IDEC Taiwan Corporation**  
Tel: +886-2-2698-3929  
[service@tw.IDEC.com](mailto:service@tw.IDEC.com)

©2014 IDEC Corporation. All Rights Reserved.  
Catalog No. PS9Y-B200-0 07/14 10K

Specifications and other descriptions in this catalog are subject to change without notice.